

# INSTRUCTION MANUAL

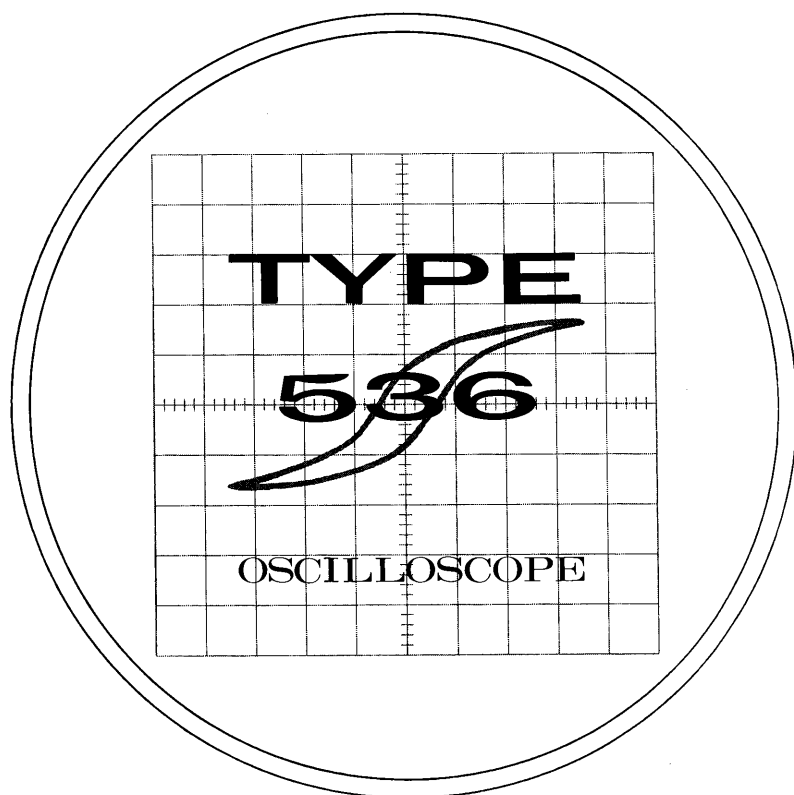

S. W. Millikan Way ● P.O. Box 500 ● Beaverton, Oregon ● Phone MI 4-0161 ● Cables: Tektronix

070-270

Sn. 2075



## WARRANTY

All Tektronix instruments are warranted against defective materials and workmanship for one year. Tektronix transformers, manufactured in our own plant, are warranted for the life of the instrument.

Any questions with respect to the warranty mentioned above should be taken up with your Tektronix Field Engineer.

Tektronix repair and replacement-part service is geared directly to the field, therefore all requests for repairs and replacement parts should be directed to the Tektronix Field Office or Representative in your area. This procedure will assure you the fastest possible service. Please include the instrument Type and Serial number with all requests for parts or service.

Specifications and price change privileges reserved.

Copyright © 1961 by Tektronix, Inc., Beaverton, Oregon. Printed in the United States of America. All rights reserved. Contents of this publication may not be reproduced in any form without permission of the copyright owner.





## CONTENTS

Warranty

Section 1 Specifications

Section 2 Getting Acquainted

Section 3 Operating Instructions

Section 4 Circuit Description

Section 5 Maintenance

Section 6 Calibration

Section 7 Accessories

Section 8 Parts List and Schematics

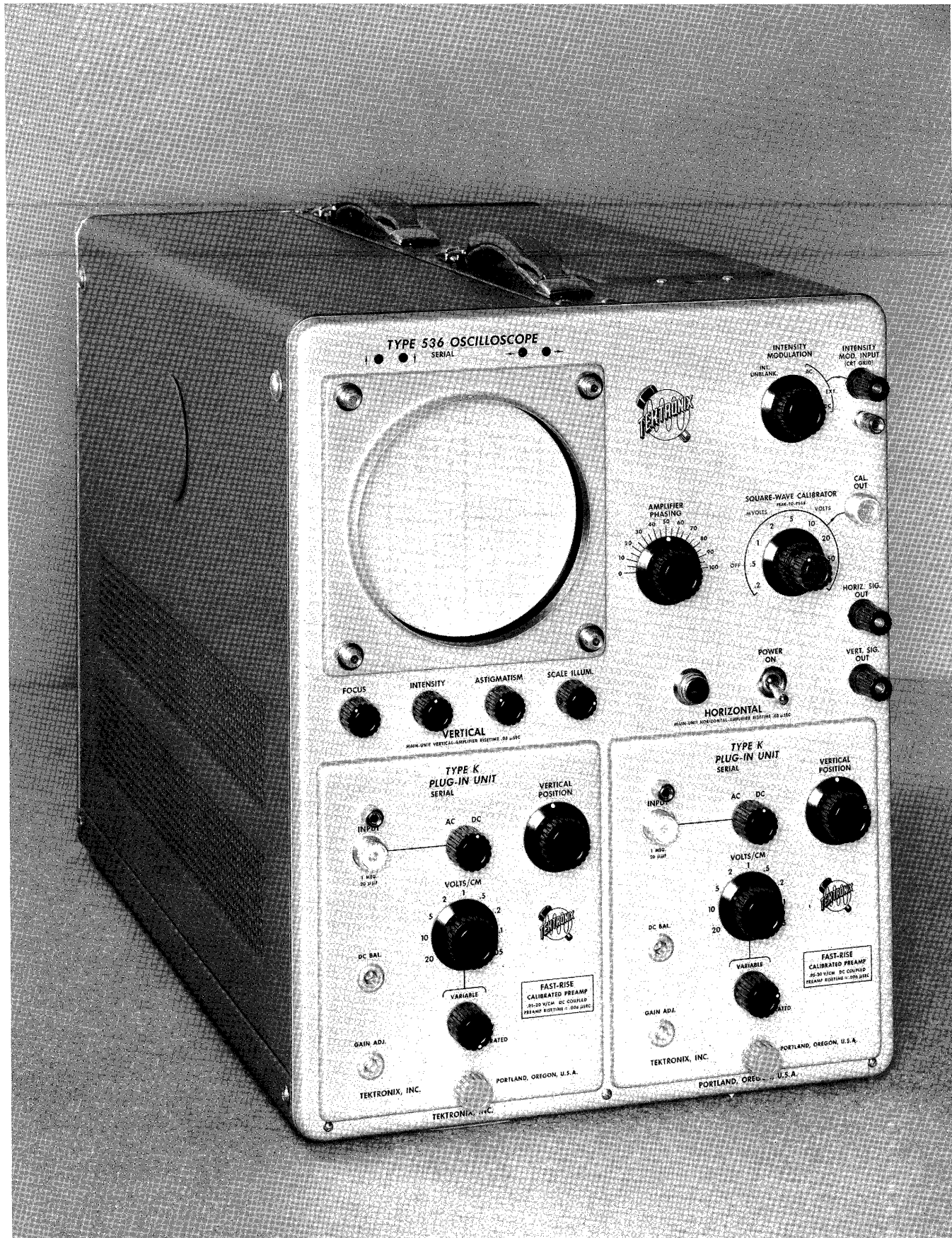

Type 536



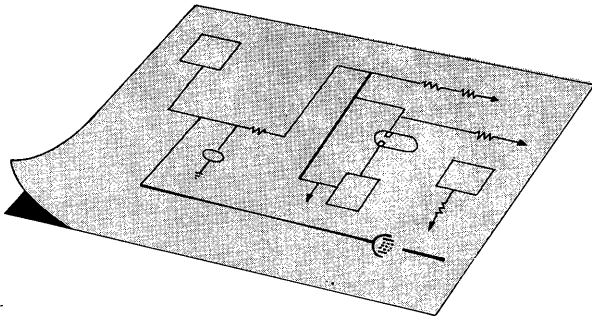

## SPECIFICATIONS

**General**

The Type 536 Cathode-Ray Oscilloscope is especially designed for making phase measurements and for curve tracing, in a range from dc to 18 mc. This feature is due to almost identical vertical and horizontal amplifiers, and to a new type cathode-ray tube. Additional versatility, provided by separately available Tektronix plug-in units, make the Type 536 Oscilloscope useful for a wide variety of general laboratory applications. For example, the use of the Type T Time-Base Generator plug-in unit provides a triggered, accurately calibrated horizontal or vertical time base.

**Vertical-Deflection System**

## Vertical-deflection factor

Deflection factor, using deflection system of Type 536 main unit alone, 0.1 volt/div.

## Transient response

Risetime of vertical-deflection amplifier in Type 536 main unit, 0.03  $\mu$ sec.

## Linear deflection

10 divisions (3- $\frac{1}{8}$  inches).

## Plug-in preamplifier unit

See applicable instruction manual or the descriptive sheets on plug-in units at the end of this section.

**Horizontal-Deflection System**

## Horizontal-deflection factor

Deflection factor, using deflection system of Type 536 main unit alone, 0.1 volt/div.

## Transient response

Risetime of horizontal-deflection amplifier in Type 536 main unit, 0.03  $\mu$ sec.

## Linear deflection

10 divisions (3- $\frac{1}{8}$  inches).

## Plug-in preamplifier unit

See applicable instruction manual or the descriptive sheets on plug-in units at the end of this section.

**Other Characteristics**

## Cathode-ray tube

Type T56P2

(P1, P7 and P11 phosphors optional).

Accelerating potential: 4,000 volts.

Deflection factors, with direct connection to deflection plates:

Vertical—10 volts/divisions, nominal.

Horizontal—10 volts/division, nominal.

## Voltage calibrator

Eighteen fixed peak-to-peak voltages from 0.2 millivolt to 100 volts.

Accuracy—3 percent.

Waveform—Square wave at about 1 kc.

## Amplifier-phasing control

Adjusts the relative deflection-system phase to compensate for minor variations between plug-in units and cables.

## Power requirements

105-125 v, or 210-250 v, 50-60 cps, 625 watts.

## Ventilation

Filtered, forced-air.

## Finish

Photo-etched, anodized panel. Blue-wrinkle cabinet.

## Dimensions

24" long, 13" wide, 16- $\frac{3}{4}$ " high.

## Weight

57 pounds.

PLUG-IN PREAMPLIFIER CHARACTERISTICS FOR TYPE 536 OSCILLOSCOPE

PLUG-IN TYPE	CALIBRATED DEFLECTION FACTOR	PASSBAND	RISETIME	INPUT CAPACITANCE
TYPE A Wide-Band DC Coupled	0.05 v/cm to 20 v/cm	dc to 10 mc	35 nsec	47 pf
TYPE B Wide-Band High-Gain	5 mv/cm to 0.05 v/cm 0.05 v/cm to 20 v/cm	2 c to 9 mc dc to 10 mc	40 nsec 35 nsec	47 pf
TYPE CA Dual-Trace DC Coupled	0.05 v/cm to 20 v/cm	dc to 10 mc	35 nsec	20 pf
TYPE D High-Gain AC Coupled Differential	1 mv/cm to 50 v/cm†	dc to 2 mc	0.18 $\mu$ sec	47 pf
TYPE E Low-Level AC Coupled Differential	50 $\mu$ v/cm to 10 mv/cm	0.06 cycles to 60 kc	6 $\mu$ sec	50 pf
TYPE G Wide-Band DC Coupled Differential	0.05 v/cm to 20 v/cm	dc to 10 mc	35 nsec	47 pf
TYPE H DC Coupled High-Gain Wide-Band	0.005 v/cm to 20 v/cm	dc to 9.5 mc	37 nsec	47 pf
TYPE K Fast-Rise DC Coupled	0.05 v/cm to 20 v/cm	dc to 11 mc	31 nsec	20 pf
TYPE L Fast-Rise High-Gain	5 mv/cm to 2 v/cm 0.05 v/cm to 20 v/cm	3 mc to 10 mc dc to 11 mc	35 nsec 31 nsec	20 pf
TYPE N* Pulse Sampling	10 mv/cm	600 mc	0.6 nsec	Input Impedance, 50 ohms
TYPE Q* Strain Gage	10 $\mu$ strain/div to 10,000 $\mu$ strain/div	dc to 6 kc	60 $\mu$ sec	Adjustable
TYPE T* is a Time-Base Generator				
TYPE Z* Differential Comparator	0.05 v/cm to 25 v/cm	dc to 9 mc	40 nsec	27 pf

\*More data available on the special purpose plug-in units in the following paragraphs.

†At sensitivities greater than .05 v/cm, maximum bandpass is less than 2 mc. At 1 mv/cm, it is approximately 350 kc.



## PLUG-IN CHARACTERISTICS APPLICABLE TO BOTH VERTICAL AND HORIZONTAL DEFLECTION SYSTEMS

### Type N

The Type N Sampling Unit is designed for use with Tektronix plug-in type oscilloscopes. The sampling system thus formed permits the display of repetitive signals with fractional nanosecond ( $10^{-9}$  second or nsec) risetime. By taking successive samples at a slightly later time at each recurrence of the pulse under observation, the Type N reconstructs the pulse on a relatively long time-base. Specifications of the Type N include a risetime of 0.6 nsec, corresponding to a maximum bandpass of approximately 600 mc; a sensitivity of 10 mv/cm with 2 mv or less noise; and a dynamic range of  $\pm 120$  mv minimum linear range before overloading results.

Accidental overload of  $\pm 4$  volts dc is permissible.

### Type Q

The Type Q Plug-In Unit permits any Tektronix convertible oscilloscope such as the Type 536 to be operated with strain gages and other transducers. Excitation voltages for the strain gages and transducers are provided by the plug-in unit. The unit provides high gain, low noise, and extremely low drift. Frequency response of the Type Q Plug-In Unit is DC to 6 kc; risetime is approximately 60 microseconds. Strain sensitivity is calibrated in 10 steps from 10 micro-strain per major graticule division to 10,000 microstrain per division, and is continuously variable between steps.

### Type T

The Type T Time-Base Generator provides sawtooth sweep voltages from 0.2  $\mu$ sec/div to 2 sec/div. The trigger source may be line frequency, external, ac or dc coupled, automatic or high-frequency sync. The triggering point can be on either rising or falling slope of the waveform, and triggering level is adjustable. A signal of 0.2 volts to 50 volts is required for triggering.

### Type Z

The Type Z Plug-In Unit extends the accuracy of oscilloscope voltage measurements. It can be used in three modes of operation: (1) as a conventional preamplifier, (2) as a differential input preamplifier, or (3) as a calibrated differential comparator. With sensitivity of 50 mv/cm and insertion voltage range of  $\pm 100$  volts, the effective scale range is  $\pm 2000$  cm. Maximum resolution of the Type Z Unit is .005%.

As a conventional preamplifier, the Type Z Unit offers a passband of dc to 9 mc with the Type 536 for signals that do not overscan the screen. The deflection factors are 0.05 v/cm to 25 v/cm in 9 fixed, calibrated steps.

As a differential input preamplifier, the Type Z accepts a common-mode signal level  $\pm 100$  volts with input attenuation X1, and offers a common-mode rejection ratio of 40,000 to 1. Maximum input signal is  $\pm 1$  volt/7 nsec, or  $-1$  volt/5 nsec.

As a calibrated differential comparator, the Type Z makes available three comparison voltage ranges; from zero to  $\pm 1$  volt, zero to  $\pm 10$  volts, and zero to  $\pm 100$  volts.





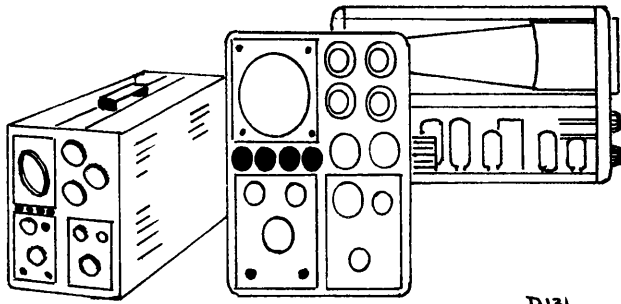

D131

## GETTING ACQUAINTED

### General

In order to help you begin using your new oscilloscope as soon as possible, we have outlined in this section some of the more frequently encountered operations when the Type 536 Oscilloscope is operated in a conventional, triggered manner. Other ways of operating the Type 536 Oscilloscope are covered in the Operating Instructions section of this manual.

A conventional oscilloscope provides us with a means of actually looking at some voltage waveform that we are interested in. To accomplish this, we feed this waveform into the input connector on the oscilloscope panel. In this case, we use the oscilloscope so that the display on the screen shows how the voltage of this waveform changes with time.

The following instructions illustrate the use of the Type 536 in conjunction with the Type T Time-Base Generator Plug-In Unit and the Type K Plug-In Pre-amplifier. The square-wave CALIBRATOR output of the oscilloscope is used for the vertical signal in this demonstration.

### Initial Control Settings

Insert the Type K Plug-In Unit into the left-hand or VERTICAL plug-in receptacle in the front panel of the Type 536 Oscilloscope. Insert the Type T Time-Base Generator into the right-hand or HORIZONTAL plug-in receptacle. Set the front-panel controls as follows:

#### Type 536

INTENSITY	full left (counterclockwise)
INTENSITY MODULATION	INT. UNBLANK
CALIBRATOR (red knob)	VOLTS
CALIBRATOR (black knob)	10
POWER	ON

#### Type T

TRIGGER SLOPE	+EXT.
TRIGGERING MODE	AUTO.
TRIGGERING LEVEL	full right (clockwise)
STABILITY	PRESET
5X MAGNIFIER	OFF
TIME/DIV (black knob)	.5 MILLISEC
VARIABLE (red knob)	CALIBRATED
POSITION (red and black knobs)	centered

#### Type K

VOLTS/CM (black knob)	5
VARIABLE (red knob)	CALIBRATED
AC-DC	AC
VERTICAL POSITION	centered

Connect a jumper from the CAL. OUT connector on the oscilloscope front panel to the INPUT connector on the Type K Plug-In Unit. Connect another jumper from the VERT. SIG. OUT connector on the oscilloscope to the TRIGGER INPUT connector on the Type T Plug-In Unit.

Turn the INTENSITY control to the right until a horizontal trace of useful brightness appears on the screen. Adjust the FOCUS control for the sharpest trace. The display on the screen should now be a square wave. Adjust the ASTIGMATISM control, and slightly readjust the FOCUS and INTENSITY controls, so that the display has the best sharpness and suitable brightness.

Center the display on the graticule by means of the positioning controls. The VERTICAL POSITION control on the Type K Plug-In Unit will control the vertical positioning, while the POSITIONING control on the T Plug-In Unit will control the horizontal positioning.

### EFFECTS OF THE TYPE T TIME-BASE GENERATOR CONTROLS

#### Triggering; the AUTO. mode

The CALIBRATOR square wave you have been looking at is a periodic signal—that is, each wave is identical to every other wave. We got a stable (stationary) display of this waveform by setting the oscilloscope controls so that each

horizontal sweep of the spot across the screen started at a given point on the waveform we were looking at. These settings were given in the table above. For present purposes, the starting of each horizontal sweep across the screen can be called "triggering" the sweep. As in the procedure above, this can be accomplished with a minimum of adjustment by

## Getting Acquainted — Type 536

setting the red TRIGGER SELECTOR knob in the AUTO. (automatic) position. That is, we used the AUTO. mode of triggering.

Because of its simplicity of operation, the AUTO. mode is one of the most useful triggering modes. In particular, you don't have to adjust the TRIGGERING LEVEL or STABILITY controls when you use the AUTO. mode. Uses of these controls are described later in this manual.

### Effect of the POSITION control

Turn the POSITION control back and forth, and notice that the display moves to the left and to the right on the screen. Note especially that if you position the knob to the extreme right, then one of the beam-position indicator lamps located above the graticule will indicate that the display is positioned off center toward the right.

Now reset the POSITION control to return the display to the center of the screen.

### Effect of the TIME/DIV controls

Turn the black TIME/DIV knob successively to positions both to the right and to the left of the 100 MICROSEC position. Notice that the display expands or contracts horizontally as this switch is turned.

Reset the TIME/DIV switch to the 100 MICROSEC position.

Turn the red VARIABLE control to the left. Notice that this contracts the display horizontally, so that the number of cycles appearing on the screen is increased.

Now reset the VARIABLE control to the CALIBRATED position.

The above operations point up the fact that the TIME/DIV switch (black knob) and the VARIABLE control (red knob) control the number of cycles of the display which appear on the screen when a waveform having a given fixed repetition frequency is displayed.

### Effect of the 5X MAGNIFIER

Turn the 5X MAGNIFIER switch to the ON position. Notice the resulting horizontal expansion of the trace. Turn this switch from ON to OFF and back several times. Observe that the portion of the waveform which occupies the middle two centimeters of the graticule length when the switch is at OFF is expanded to occupy the entire graticule length when the switch is at ON.

With the 5X MAGNIFIER switch at ON, turn the POSITION control throughout its range, and notice that the display has been expanded beyond the limits of the graticule.

Now reset the 5X MAGNIFIER switch to the OFF position.

### Effect of the black TRIGGER SLOPE knob

Carefully observe the part of the display which appears at the left-hand end of the graticule. Notice that the trace

begins during a rising portion of the square wave, at the left-hand end of the graticule. That is, the sweep is triggered at a time when the slope of the wave is positive (see Fig. 2-1). This is because the black TRIGGER SLOPE knob is set to +EXT., rather than to -EXT.

Now turn the black TRIGGER SLOPE knob to -EXT. Observe that the display turns upside down, so that it now begins during a falling portion of the square wave, at the left-hand end of the graticule. That is, the sweep is triggered at a time when the slope of the wave is negative.

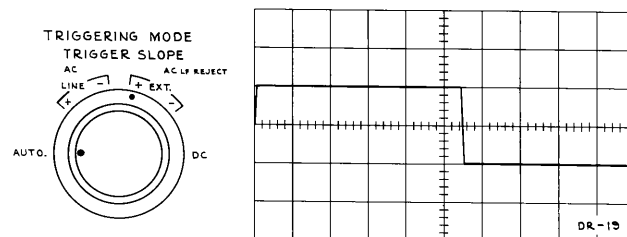

Fig. 2-1. Triggering on the rising portion of a waveform. The TRIGGER SLOPE switch is at +EXT., so that the display starts during the positive-going part of the waveform (that is, during that part of the waveform where the slope is positive).

Note that one of the purposes of the black TRIGGER SLOPE knob is to provide control over whether the sweep is triggered when the slope of the waveform is positive, or whether it is triggered when the slope of the waveform is negative, as just described. Turn the black TRIGGER SLOPE knob back and forth between +EXT. and -EXT. several times, observing the left-hand end of the display carefully to see how you thus start the sweep on either a rising or falling part of the waveform.

Now return the black TRIGGER SLOPE knob to +EXT.

### The AC triggering mode; effect of the TRIGGERING LEVEL control

Check that the black TRIGGER SLOPE knob is set at +EXT., that the TRIGGERING LEVEL control is turned full right and that the STABILITY control is at PRESET. Turn the TRIGGERING MODE switch to AC. The trace should now disappear from the screen.

Slowly turn the TRIGGERING LEVEL control to the left until the trace reappears; adjust this control for a stable display of the CALIBRATOR square wave. We say that triggering is now being effected in the AC mode.

Remove the CALIBRATOR lead from the INPUT connector on the Type K Plug-In Unit. Note that this causes the trace to disappear. Now reconnect the CALIBRATOR lead to the INPUT connector so that the trace reappears.

Next, slowly turn the TRIGGERING LEVEL control several times back and forth throughout its range from —, through 0, to +. Carefully observe the left-hand end of the display while you do this. Note that there is a certain part of the range of this control provides a display; settings too far



towards the — or the + marks on the panel result in no display.

Also notice that, in the part of the range of the TRIGGERING LEVEL control where you get a display, this control determines the height or "level" of the point on the waveform where the trace starts. If you set this control more towards the — part of its range, the display starts on the lower part of the waveform. If you set this control more towards the + part of its range, the display starts higher on the waveform (see Fig. 2-2). Since the TRIGGER SLOPE knob is set at +EXT., the display in each case starts on the rising part of the waveform (where the slope is positive).

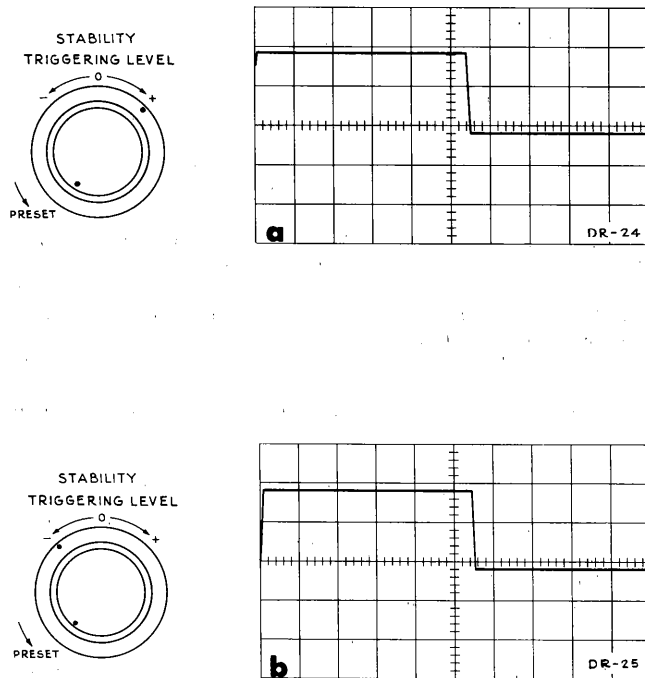

Fig. 2-2. Effect of the TRIGGERING LEVEL control when the TRIGGERING MODE switch is in the AC position. (a) When the TRIGGERING LEVEL control is in the + part of its range, the display starts during the upper half of the leading edge. (b) When the TRIGGERING LEVEL control is set in the — part of its range, the display starts during the lower half of the leading edge. (In each of the two displays above, the TRIGGER SLOPE switch is at +EXT., so that the display starts during the rising part of the waveform.)

Now turn the TRIGGER SLOPE knob to +EXT., so that the waveform appears upside-down—that is, it starts on the falling part of the waveform (where the slope is negative). Repeat the observations of the previous paragraph, and note that you can still control the height of the point where the trace starts by means of the TRIGGERING LEVEL control (see Fig. 2-3).

Reset the black TRIGGER SLOPE knob to +EXT. Now turn the VERTICAL POSITION control on the Type K Plug-In Unit back and forth, so that the display is moved up and down on the graticule. Observe the left-hand end of the display while you do this. Notice that, for a fixed setting of the TRIGGERING LEVEL control, the trace always starts at a given point on the waveform, regardless of the setting of the VERTICAL POSITION control.

These brief statements can be made to compare the AC and AUTO. modes of triggering:

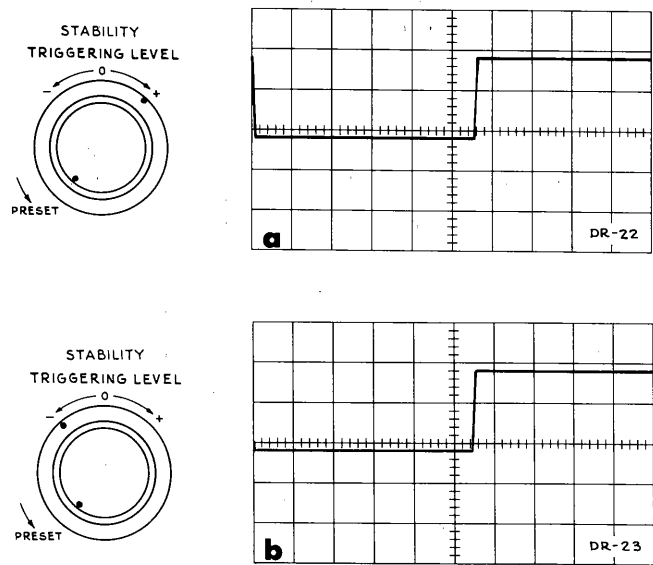

Fig. 2-3. Effect of the TRIGGERING LEVEL control when the TRIGGERING MODE switch is in the AC position. These drawings differ from those of Fig. 4 in that the black TRIGGER SLOPE knob is set at —EXT. This causes the display to start during the falling or negative-slope part of the waveform. (a) When the TRIGGERING LEVEL control is set in the + part of its range, the trace starts during the upper half of the waveform, just as it did in Fig. 4. (b) When the TRIGGERING LEVEL control is set in the — part of its range, the trace starts during the lower half of the waveform.

1. It is necessary to adjust the TRIGGERING LEVEL control when you use the AC mode of triggering, but not when you use the AUTO. mode.
2. When you use the AUTO. mode, you get a desirable horizontal reference trace on the screen, even when no input signal is used. This will be especially handy when you are testing equipment by moving the input connection from one point to another in the equipment. When you use the AC mode, no trace appears when there is no input signal.
3. In the AC mode the TRIGGERING LEVEL control provides control of the height or "level" at which the trace starts on the waveform being observed. This is not true in the case of the AUTO. mode.
4. The AUTO. mode is useful when you are looking at periodic waveforms. The AC mode is useful for both periodic waveforms and for waveforms which occur only once or at random intervals.

### The DC triggering mode

After completing the previous operation, use the VERTICAL POSITION control on the Type K Plug-In Unit to center the display vertically on the screen. Set the TRIGGERING LEVEL control for a stable display with the control located as close as possible to 0.

Turn the red TRIGGERING MODE switch to DC. If necessary, readjust the TRIGGERING LEVEL control for a stable display. You are now triggering the sweep in the DC mode.

## Getting Acquainted — Type 536

Slowly turn the TRIGGERING LEVEL control several times back and forth throughout its range from —, through 0, to +. Carefully observe the left-hand end of the display while you do this. Note that the results are very much like those you got when you used the AC mode.

Turn the black TRIGGER SLOPE knob to —EXT., and repeat the above operation. Again note that the results are similar to those you obtained when you used the AC mode. Return the black TRIGGER SLOPE knob to +EXT.

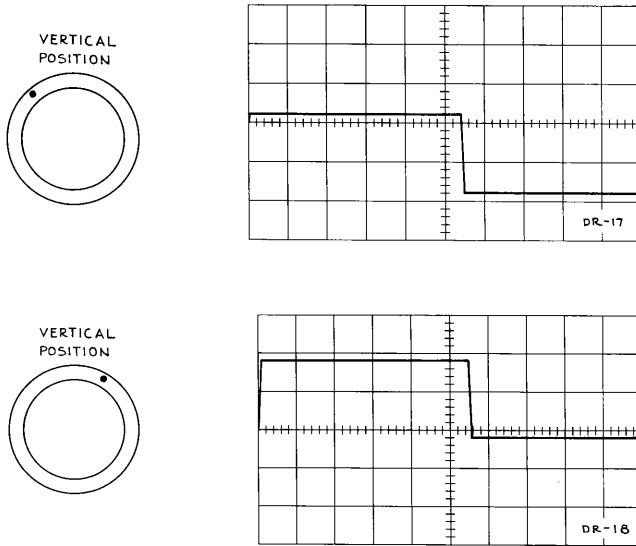

Fig. 2-4. Effect of the VERTICAL POSITION control when the TRIGGERING MODE switch is in the DC position. Even though the VERTICAL POSITION control is rotated, the displays start at the same graticule height. This is in contrast to the AC triggering mode, where the display starts at the same point on the waveform regardless of the VERTICAL POSITION control setting.

Now turn the VERTICAL POSITION control back and forth, so that the display is moved up and down on the graticule. Observe the left-hand end of the display while you do this. Notice that, for a given setting of the TRIGGERING LEVEL control, the trace always starts at a given point on the graticule, regardless of the setting of the VERTICAL POSITION control (see Fig. 2-4). (If you position the trace too high or too low, so that the waveform doesn't include this starting point, the trace disappears.)

Notice, also, that as you move the display up and down with the VERTICAL POSITION control, the waveform shifts slightly from left to right on the screen (as shown in Fig. 6), so that the starting point always has the same position on

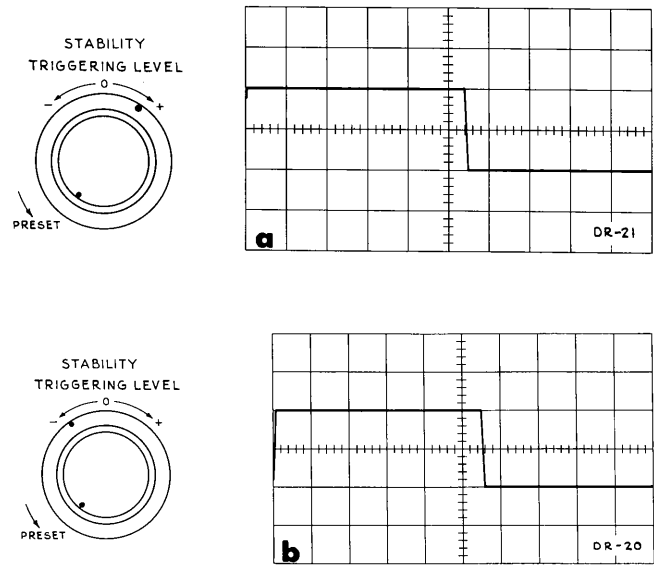

Fig. 2-5. Effect of the TRIGGERING LEVEL control when the TRIGGERING MODE switch is in the DC position. In the DC triggering mode, the setting of the TRIGGERING LEVEL control determines the elevation of the point on the graticule at which the display starts. (a) When the TRIGGERING LEVEL control is set in the + part of its range, the display starts at a point above the graticule horizontal center line. (b) When the TRIGGERING LEVEL control is set in the — part of its range, the display starts at a point below the graticule horizontal center line.

the graticule. When the TRIGGERING LEVEL is set near 0, the starting point will be near the middle of the graticule height. If you move the TRIGGERING LEVEL control towards +, the starting point will be raised, while if you move the TRIGGERING LEVEL control towards —, the starting point will be lowered (see Fig. 2-5).

The four comments at the close of the section on the AC triggering mode apply also to triggering in the DC mode. In addition, the following statements can be made to compare the DC and AC modes of triggering:

1. When you use the DC mode, the trace always starts at a given point on the graticule, for a given TRIGGERING LEVEL setting (regardless of the VERTICAL POSITION setting). But when you use the AC mode, the trace always starts at a given point on the waveform, for a given TRIGGERING LEVEL setting (regardless of the VERTICAL POSITION setting).
2. The DC mode is especially useful for viewing waveforms which change slowly.

## EFFECTS OF TYPE K PLUG-IN UNIT CONTROLS

### Effect of the VERTICAL POSITION control

Turn the VERTICAL POSITION control back and forth, and notice that this raises and lowers the display on the screen. Note especially that if you position the display off the graticule in either direction, one of the beam-position indicator

lamps, located above the graticule, will indicate in which direction the display is positioned off the screen. This tells you which way to turn the VERTICAL POSITION control in order to get the trace back on the screen.

Now reset the VERTICAL POSITION control to return the display to the center of the screen.



### Effect of the AC-DC switch

Turn the AC-DC switch from AC to DC. Notice the vertical shift in the position of the trace. This is due to the fact that the output waveform from the SQUARE-WAVE CALIBRATOR has both an ac (square wave) component and a dc component. When the AC-DC switch is in the AC position, the effect of the dc component of the waveform is excluded from the display. When this switch is in the DC position, the display indicates both the ac and dc component of the waveform being viewed. The dc component causes the entire display to rise or fall on the screen.

### Effects of the VOLTS/CM controls

Turn the black VOLTS/CM knob successively to positions both to the right and to the left of the 5 position. Notice

that when you set the VOLTS/CM switch to higher-numbered positions, the amount of vertical deflection produced on the screen by the SQUARE-WAVE CALIBRATOR waveform is reduced. In a like manner, the amount of deflection is increased as the control is turned to the lower-number positions.

Reset the black VOLTS/CM knob to the 5 position.

Turn the red VARIABLE knob to the left. Notice that this reduces the amount of vertical deflection produced on the screen by the oscilloscope SQUARE-WAVE CALIBRATOR waveform. Reset the VARIABLE control to the CALIBRATED position.

The above operations point up the fact that the VOLTS/CM switch (black knob) and the VARIABLE control (red knob) provide control of the amount of vertical deflection which results from feeding a waveform having a given peak-to-peak voltage into the INPUT connector.

## EFFECTS OF THE TYPE 536 OSCILLOSCOPE CONTROLS

### Effects of the SQUARE-WAVE CALIBRATOR controls

Turn the black PEAK-TO-PEAK knob to positions both to the right and to the left of the 10 position. Notice that when you set the PEAK-TO-PEAK switch to the higher-numbered positions, the amount of vertical deflection on the screen is increased. Similarly, when the switch is turned to lower-numbered positions, the vertical deflection is decreased.

Reset the black PEAK-TO-PEAK control to the 10 position.

Turn the red MILLIVOLTS-VOLTS knob to MILLIVOLTS. Notice that this reduces the amount of vertical deflection greatly. Reset the control to the VOLTS position.

The above operations point up the fact that the SQUARE-WAVE CALIBRATOR controls provide control of the output-signal amplitude available at the CAL. OUT connector.

### Effects of the other front-panel controls

When using the Type 536 Oscilloscope in a conventional, triggered manner, the INTENSITY MODULATION control is normally left in the INT. UNBLANKING position. Uses for this control and the associated connector are explained in the Operating Instructions section of this manual.



# SECTION 3

## OPERATING INSTRUCTIONS

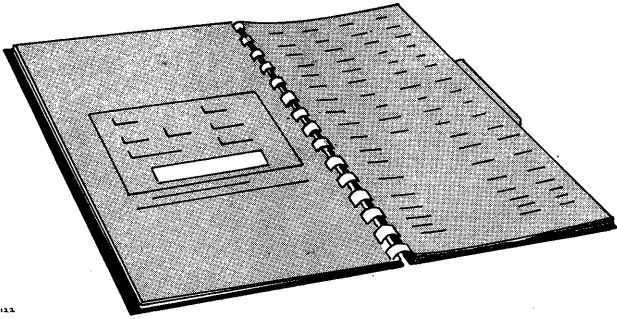

### SPECIAL INSTRUCTIONS

1. Turn INTENSITY toward the left when spot is stopped, or moving slowly, to prevent damage to the phosphor on the face of the cathode-ray tube.

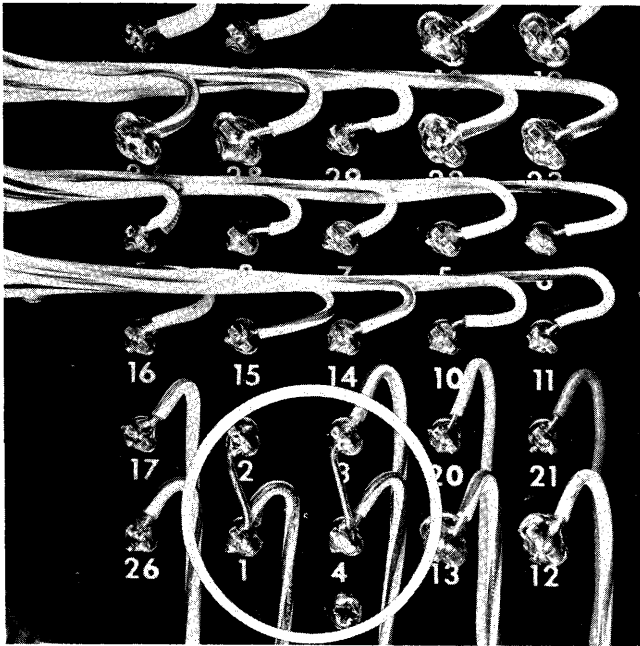

Fig. 3-1. Transformer connections for 117-volt operation.

2. Operate the oscilloscope from a power-line voltage as nearly as possible in the middle of the range for which the transformer is connected. The power-line voltage and operating range is indicated on a metal tag at the rear of the instrument. If you want to operate your oscilloscope using an input voltage other than indicated, use the information given in Figures 3-1, 3-2 and 3-3.

3. Make certain the air intake at the rear of the oscilloscope is not obstructed and that the air filter is clean.

### NOTE FRONT-PANEL COLORS

RED letters go with RED knobs.

BLACK letters go with BLACK knobs.

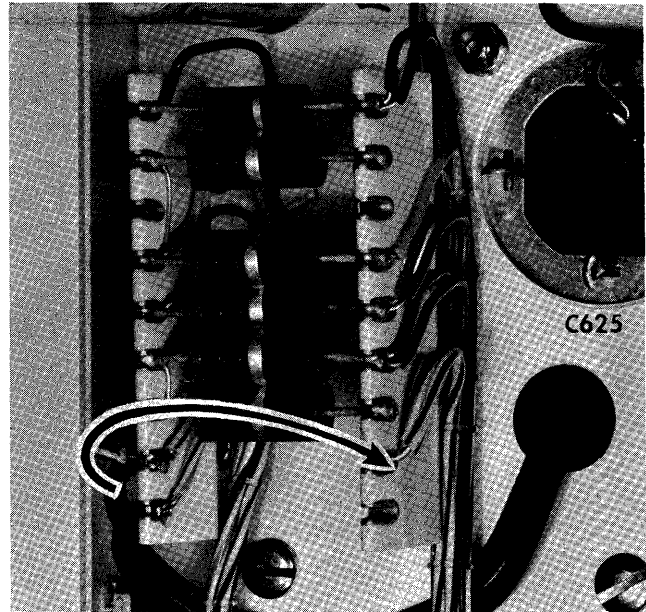

Fig. 3-2. Fan connections for 117-volt operation. For 234-volt operation move upper fan lead to slot indicated by the arrow.

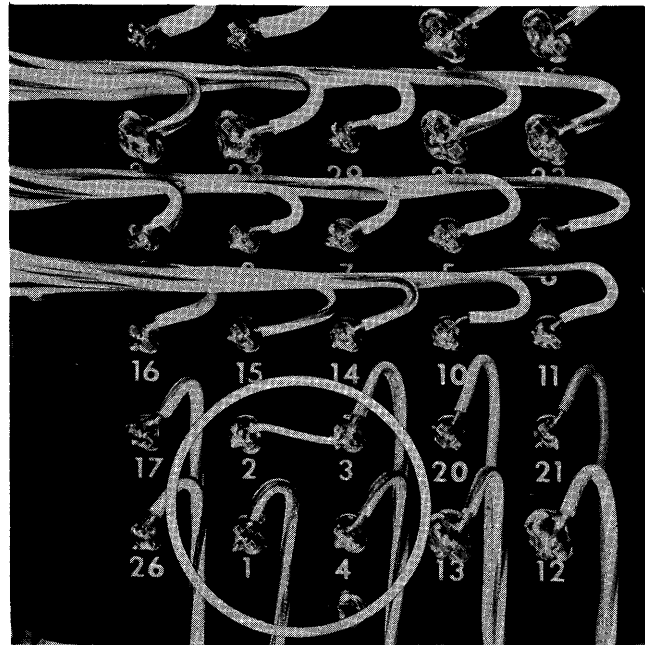

Fig. 3-3. Transformer connections for 234-volt operation.



Fig. 3-4. For information on care of the air filter, refer to the Maintenance section.

## PRELIMINARY INSTRUCTIONS

### Cooling

A fan maintains safe operating temperature in the Type 536 Oscilloscope. Air is circulated through a filter and over the rectifier and other components. The instrument must therefore be placed so the air intake, at the rear, is not blocked. The air filter must be kept clean to permit adequate air circulation. Instructions for maintaining this filter are found in the Maintenance section of this Instruction Manual. If the interior temperature does rise too high for some reason, a thermal cutout switch will disconnect the power and keep it disconnected until the temperature drops to a safe value.

### Time-delay relay

A time-delay relay delays the application of the rectified dc to the circuits long enough for all heaters to reach operating temperature. The time delay is approximately 25 seconds. If you switch the ac power off, even briefly, the time-delay relay will delay reapplication of the dc.

### Power requirements

The regulated power supplies in the Type 536 will operate with line voltages from 105 to 125 volts or from 210 to 250 volts. For maximum dependability and long life, the voltage should be near the center of this range.

Voltages outside of these limits may cause hum or jitter on the trace and cause your Type 536 to lose calibration. Be sure the line voltage is correct if indications such as these are present. Unless tagged otherwise, your oscilloscope is connected at the factory for 117-volt operation.

## GENERAL INSTRUCTIONS

### Overloading of the deflection systems

Above 10 mc, it is possible to overload without having full 10 division deflection. You will see this as distortion of the oscilloscope display. Reduce the size of the crt display to minimize the distortion.

### Plug-in units

The Type 536 Cathode-Ray Oscilloscope uses plug-in units for both HORIZONTAL and VERTICAL deflection systems. A list of available plug-in units is located in the rear of this Instruction Manual.

We recommend that you turn your Type 536 off while changing plug-in units. Although the removal of one plug-in unit will not affect the instrument, if both plug-in units are taken out at the same time, the power supply may go out of regulation due to the reduced loads and this may damage components in the instrument.

### Positioning the trace

Controls for positioning the trace are located on the plug-in units. The POSITION control on the plug-in unit located in the right or HORIZONTAL side positions the trace horizontally. Similarly, you use the POSITION control on the plug-in unit that is located in the left or VERTICAL side to position the trace vertically.

## TYPICAL OPERATION

### Using a time-base plug-in unit

AC, AC LF REJECT and DC modes

1. Turn POWER switch off.
2. Connect the power cord to a source of 117-volt, 60-cycle power.
3. Insert a preamplifier plug-in unit into the VERTICAL side. Insert the Type T Plug-In Unit into the HORIZONTAL side.
4. Turn the POWER switch to ON.
5. Set the Type 536 controls as follows:

INTENSITY	full left
FOCUS	centered
ASTIGMATISM	centered
INTENSITY MODULATION	INT. UNBLANK

Set the red CALIBRATOR control to VOLTS, the black CALIBRATOR control to 10.

Set the black VOLTS/CM switch on the VERTICAL plug-in unit to 5.

6. Set the Time-Base plug-in unit controls as follows:

TRIGGER SLOPE	+EXT
TRIGGERING MODE	AC
TRIGGERING LEVEL	full right
STABILITY	full right
5X MAGNIFIER	OFF
TIME/CM	.5 MILLISEC
POSITION	centered

7. Connect a lead from CAL OUT to the VERTICAL INPUT.

8. Connect a lead from VERT. SIG. OUT to TRIGGER INPUT on the Type T plug-in unit.

After 30 seconds warm-up time, turn the INTENSITY control right until the trace is visible on the screen. Turn the STABILITY control left until the trace disappears, then two or three degrees further left. Next, turn the TRIGGERING LEVEL control left for a stable display of the input signal. You may need to adjust the STABILITY control slightly.

The procedure just described for operating the STABILITY and TRIGGERING LEVEL controls is the procedure to use for the AC, AC LF REJECT, and DC modes of triggering. This procedure is now repeated in step form for your easy reference.

For AC, AC LF REJECT, and DC modes of triggering:

1. Turn the TRIGGERING LEVEL and STABILITY controls full right, getting a free-running sweep.
2. Turn the STABILITY control left until the trace disappears, then two or three degrees further left.
3. Turn the TRIGGERING LEVEL control left for a stable display of the input signal. You may need to adjust the STABILITY control slightly.

### AUTO mode

To use the AUTO mode of triggering, connect the trigger signal to the TRIGGER INPUT. Set the TRIGGER SLOPE switch to +EXT and the TRIGGERING MODE switch to AUTO. The time-base generator will now synchronize with most trigger signals between the frequencies of 60 cycles and 2 megacycles. The STABILITY and TRIGGERING LEVEL controls are switched out of the circuit in the AUTO mode.

### HF SYNC mode

In the HF SYNC mode the TRIGGERING LEVEL control is not used. Synchronized operation of the sweep is obtained by adjusting the STABILITY control for a stationary presentation. The HF SYNC mode will operate with most signals from 5 megacycles to about 15 megacycles.

You will find specific information on Triggering Modes in the Instruction Manual for the Type T Time-Base Generator Plug-In Unit.

### Amplifier-phasing adjustment

We recommend that you use two plug-in units of the same type when making phase measurements and curve tracing. The AMPLIFIER PHASING control permits a slight adjustment for phase-shift variations between two plug-in units of the same type. You will usually make this adjustment just before taking your measurements. To make the AMPLIFIER PHASING adjustment:

1. Turn POWER switch off.
2. Connect the power cord to a source of 117-volt 60-cycle power.
3. Insert two preamplifier plug-in units of the same type into the Type 536.
4. Turn the POWER switch to ON.
5. Set the Type 536 controls as follows:

INTENSITY	full left
FOCUS	centered
ASTIGMATISM	centered

6. Set the controls on both plug-in units as follows:

VOLTS/CM	both to same position
VARIABLE	full right
VERTICAL POSITION	centered

7. Connect two coaxial cables of equal length to terminating resistors. The two cables are not required to have the same impedances; however, each cable must be terminated in a resistance equal to its nominal impedance. Refer to the Accessories section at the back of this manual, for a listing of cables and terminating resistors. Connect the cable-terminating resistors to the INPUT receptacles of the VERTICAL and HORIZONTAL plug-in units. Join the unterminated ends of the cables to the symmetrical branches of a coaxial tee. Connect a sine-wave generator, such as the Tektronix Type 190A, to the coaxial tee. Use an adapter, if necessary. Set the Type 190A to the frequency to be used in the phase measurements.
8. Turn the INTENSITY control right to give a trace.
9. With about 5 cm vertical deflection, adjust the AMPLIFIER PHASING control so that the oscilloscope displays a straight line of positive slope, inclining at 45 degrees.

The vertical and horizontal deflection systems are now adjusted to have the same amount of phase shift. Always turn the INTENSITY control left before removing signals from both deflection systems. Leaving a spot stationary on the crt screen can damage the phosphor.

### Phase measurements

Phase-shift differences between the HORIZONTAL and VERTICAL amplifier channels of the Type 536 have been minimized by careful design. Using suitable plug-in units of the same kind, internal AMPLIFIER PHASING can be accomplished for frequencies as high as 20 mc. We recommend



## Operating Instructions — Type 536

the use of two Type K Plug-In Units for measurements above 8 mc. One AMPLIFIER PHASING adjustment, at the highest measuring frequency, is sufficient for measurements of moderate precision. If higher precision is required, you can pre-calibrate the scale of the AMPLIFIER PHASING control, as a function of frequency, for a particular pair of plug-in units. The plug-in unit input attenuators cannot be perfectly compensated for all frequencies. Slight high-frequency phasing errors are introduced when the plug-in unit VOLTS/CM switches are stepped from range to range.

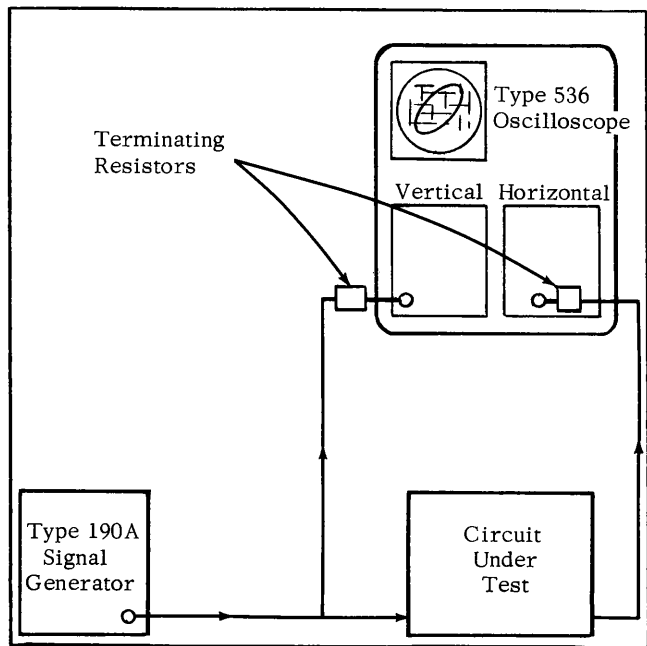

Fig. 3-5. Circuit connections for phase measurements.

A typical setup for phase measurements on an external circuit is shown in Fig. 3-5. Examples of circuits that can be tested are amplifiers, transformers and filters. We will describe high-frequency phase measurements where coaxial connections are required. Measurements at audio frequencies are similarly performed. To make the phase measurements:

1. Select the coaxial cables and terminations to be used in your phase measurements. The impedance of the cable to the HORIZONTAL channel should match the output impedance of the circuit under test. Perform the AMPLIFIER PHASING adjustment as outlined in the preceding section.
2. Make the circuit connections as shown in Fig. 3-5.
3. Adjust the plug-in unit VOLTS/CM controls until you get a suitable ellipse on the oscilloscope screen. The height of the ellipse is not critical; use any convenient height within the graticule area. Above 10 mc, the size of the ellipse will have to be reduced to prevent distortion due to overloading of the deflection systems. Fig. 3-6 shows the elliptical pattern displayed for a phase angle of 45 degrees. The procedure for measuring the phase angle is independent of the shape of the ellipse.

4. Use the POSITION control of the plug-in unit in the HORIZONTAL channel to center the ellipse about a vertical graticule line. Make the dimensions  $a$  and  $b$ , shown in Fig. 3-6, equal to each other. Within reasonable limits, the specific value chosen for the dimensions  $a$  and  $b$  does not affect the accuracy of the measurements.
5. Measure the dimensions  $A$  and  $B$  as shown in Fig. 4-2.
6. Using the formula shown in Fig. 4-2 calculate the sine of the desired phase angle  $\theta$ . Determine the angle  $\theta$  from your slide rule or a trigonometric table of sines.

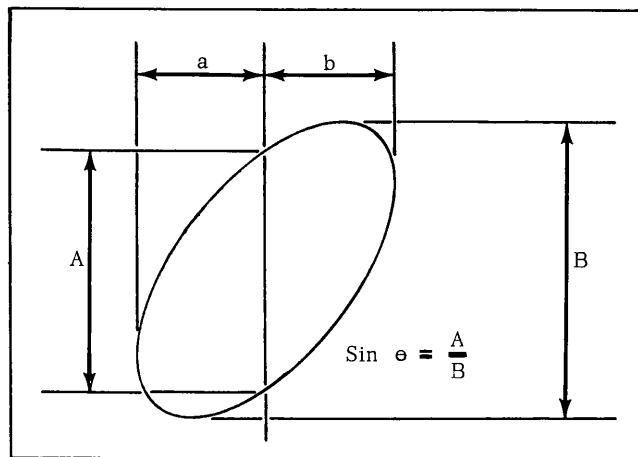

Fig. 3-6. A typical ellipse.

The inclination of the ellipse gives an indication of the phase relationship for angles between 0 and 180 degrees. A straight line of positive slope (inclining to the right) indicates a 0-degree phase relationship. Elliptical patterns will be obtained for intermediate phase angles. As the phase angle is increased, the inclination of the ellipse will change progressively. One axis of the ellipse will be vertical for a phase angle of 90 degrees. As the phase angle increases beyond 180 degrees, the inclination of the ellipse will regress—repeating, in reverse order, the elliptical patterns described above for angles less than 180 degrees. Confusion in interpreting the data is often avoided, if rough sketches of the elliptical patterns are included on the data sheet. The sign (+ or -) of the phase angle can usually be determined from a knowledge of the circuit being tested. An interchange of the cables to the HORIZONTAL and VERTICAL channels will not alter the sequence of patterns described in this paragraph. Use whichever connection is more convenient.

### Curve tracing

The horizontal and vertical deflection systems of the Type 536 Cathode-Ray Oscilloscope are voltage-sensitive. Therefore, in using your Type 536 for curve tracing, voltage is always plotted as a function of the independent and dependent variables. The independent variable is usually plotted along the horizontal axis while the dependent variable is normally plotted along the vertical axis. The repeti-

tion rate of the independent variable should be chosen to give a bright, consistent display. Repetition rates of 60 cps and greater will give an intelligible presentation. Below 60 cps you will obtain the desired information more readily using photographic techniques.

To assure coincidence of the horizontal and vertical axes at the origin, the Type 536 amplifiers and preamplifiers should be adjusted to like amounts of phase shift. The procedure for this adjustment is described in a preceding paragraph, titled Amplifier Phasing.

## FUNCTIONS OF CONTROLS AND CONNECTORS

### CRT controls

FOCUS	Control to adjust the beam for maximum sharpness of the trace.
INTENSITY	Control to vary the brightness of the trace.
ASTIGMATISM	Control used in conjunction with the FOCUS control to adjust the beam for maximum sharpness of the trace.
SCALE ILLUM.	Control to vary the brightness of the graticule illumination.
INTENSITY MODULATION	Three-position switch selects signal to crt grid.
INTENSITY MOD. INPUT	Coaxial connector to crt grid through EXT positions of the INTENSITY MODULATION switch.

### Auxiliary functions

AMPLIFIER PHASING	Variable capacitor to correct for slight phase differences between plug-in units.
SQUARE-WAVE CALIBRATOR (red knob)	Three-position switch turns the calibrator on and selects MILLIVOLTS or VOLTS output.
SQUARE-WAVE CALIBRATOR (black knob)	Nine-position switch selects the calibrator voltage from a precision voltage divider.
CAL. OUT	Coaxial connector from the calibrator.
HORIZ. SIG. OUT	Front-panel connector supplies a sample of the signal from the HORIZONTAL amplifier.
VERT. SIG. OUT	Front-panel connector supplies a sample of the signal from the VERTICAL amplifier.
POWER	On-off switch in the lead to the power transformer and fan.

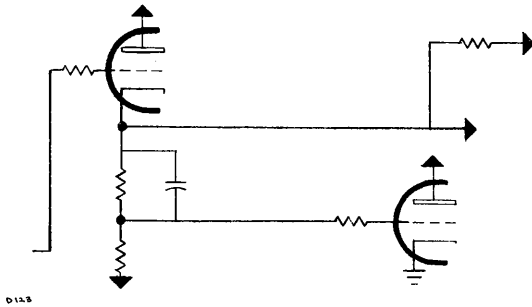

CIRCUIT  
DESCRIPTION**Introduction**

The Tektronix Type 536 is an "X-Y" oscilloscope, requiring two Tektronix Plug-In Units for operation. With two preamplifiers (plug-in units) inserted into the vertical- and horizontal-deflection circuits, the instrument may be used for making phase measurements, for curve tracing, and for other applications where deflection amplifiers with identical characteristics are required. The instrument may be used as a standard oscilloscope by inserting a Tektronix Time-Base Generator Plug-In Unit into the horizontal deflection circuit, and any of the Preamplifier Plug-In Units into the vertical deflection circuit. Or, if a calibrated vertical time-base is required or desired, the Time-Base Unit may be inserted into the vertical-deflection circuit, in which case the desired preamplifier may be inserted into the horizontal-deflection circuit.

**Deflection Amplifiers**

The Type 536 Oscilloscope has almost identical deflection amplifiers, the main difference being the configuration of the PHASING network. Since the amplifiers are almost identical, a description of the Vertical Amplifier will also be applicable to the Horizontal Amplifier.

The Vertical Amplifier consists of two stages of push-pull amplification (the Input Amplifier V304-V324 and the Output Amplifier V354-V364, (V354A & B S/N 101-614) separated by two cascaded, cathode-follower, isolating stages. The voltage gain of the amplifier, which is approximately 100 (the exact gain depends on the sensitivity of the crt), is calibrated so that a .1-volt, peak-to-peak signal, received from the plug-in unit, will produce one division of deflection on the crt.

The signal to be amplified is obtained from the plug-in unit (through pins 1 and 3 of the Inter-connecting Plug) and applied to the grids of the Input Amplifier V304-V324. The VERT. GAIN ADJ. R313 regulates the cathode degeneration, and is thus used to set the gain of the stage. In operation, this control is adjusted so that the vertical deflection on the crt agrees with the front-panel calibration of the plug-in unit when the red VARIABLE volts/div. control is set full right to the CALIBRATED position.

High-frequency compensation for the Input Amplifier is provided by the peaking coils in the plate circuits of the stage. The variable inductors L304 and L324 provide a means for adjusting the compensation for optimum results.

DC shift in the amplifier tubes... a condition whereby the dc and extremely low-frequency transconductance is less

than at higher frequencies... is compensated for by a time-constant network that shunts each plate load resistor. R326 and C364 form the RC network that shunts R304, the plate-load resistor for V304, and R333 and C362 form the RC network that shunts R324, the plate-load resistor for V324. At dc and extremely low frequencies, the impedance of these RC networks is so high that their shunting effect of the plate-load resistors is negligible. For signals in this range, the plate-load resistance remains at 1.6 K. As the frequency of the signals increases, however, the impedance of the RC networks approaches a minimum value of 150 K, which lowers the plate-load resistance to a minimum of 1.58 K. This decreases the gain of the stage slightly, for all signals above the extremely low-frequency range, and compensates for the higher transconductance of the tubes above this range.

For the frequencies at which they shunt the plate-load resistors of the Input Amplifier, these RC networks also provide a small amount of positive feedback from the Output Amplifier. This feedback, together with the dc shift compensation, makes the dc response of the amplifier equal to the mid-frequency response.

The signal to be amplified is coupled from the Input Amplifier to the Output Amplifier by the First and Second C.F. stages V333 and V343. The cathode followers present a high-impedance, low-capacitance load for the Input Amplifier; they also provide a low-impedance driving source for the Output Amplifier.

The .75-microhenry interstage inductors, together with the PHASING capacitor C352, provide for a small amount of signal delay between the Second C.F. and the Output Amplifiers. (The Signal-delay network in the Horizontal Amplifier is slightly different than that in the Vertical Amplifier, and provides a slight amount of additional signal delay. This additional delay compensates for the transit time of the electron beam between the vertical deflection plates and the horizontal deflection plates in the crt.) C352 in the Vertical Amplifier is ganged differentially with C253 (with C252 and C253 S/N 101-614) in the Horizontal Amplifier, so as the capacitance, and hence the delay time, in one circuit is decreased, the capacitance and the delay time in the other is increased. With this arrangement the signal delay time in both channels, and hence the phasing of the crt display, can be adjusted for optimum results.

The plate-loaded Output Amplifier stage provides the push-pull drive for the vertical deflection plates. High-frequency compensation for this stage is provided by the variable shunt peaking coils L350 and L356. The SCREEN ADJ. R359 regulates the voltage on the common screen grid, and is adjusted for optimum linearity in the output waveform.

## Circuit Description — Type 536

The Output Amplifier stage is also compensated for dc shift by R362 and C362 in one plate circuit, and by R364 and C364 in the other. At dc and extremely low frequencies, the impedance of the RC networks is so high that the plate-load resistance for each tube is 1.25 K (the value of the plate-load resistors R350 and R356). At higher frequencies, however, the impedance of these networks approaches a minimum value of 82K, and the load resistance for each tube is lowered to a minimum of 1.23K. The VERT. DC SHIFT COMP. control R363 provides a means for adjusting the amount of compensation for optimum results.

The Indicator Amplifier V374A regulates the voltage at the junction of the two Beam Position Indicators, and thus regulates the potential across each lamp. The BEAM POSITION INDICATOR CENTERING control R375 sets the voltage at the grid, and thus at the plate, of V374A. With the trace centered vertically on the crt, this control is adjusted so that the voltage at the plate of V374A is such a value that the potential across each lamp is less than the firing potential of the lamp. Thus, the lamps are extinguished when the trace is centered vertically on the crt. If the beam is positioned above or below the center of the crt, however, the voltage at the plate of V374A will change and one of the lamps will fire, indicating the direction in which the beam has been moved. For example, if the beam is positioned above the center of the crt, the voltage at the plate of V354 (V354B, S/N 101-614) will increase and the voltage at the plate of V364 (V354A, S/N 101-614) will decrease. This will lower the voltage at the grid of V374A, and cause the voltage at the plate of the tube to rise. This will increase the voltage across B379 and cause this lamp to fire. If the beam is positioned below the center of the crt, just the opposite condition will result and B385 will fire.

A sample of the signal at the plate of V354 is coupled by the Vert. Sig. Out C.F. V374B to a front panel connector on the instrument. The VERT. SIG. OUT. DC LEVEL ADJ. R395 is adjusted so that the dc level at the connector is zero when the beam is centered vertically on the crt.

## Power Supply

Plate and filament power for the tubes in the Type 536 Oscilloscope is furnished by a single power transformer T600. The primary has two equal tapped windings; these may be connected in parallel for 105- to 125-volt operation, or in series for 210- to 250-volt operation. Silicon rectifiers are employed for the four separate full wave, bridge-type, power supplies. (Selenium rectifiers, S/N 101-1202). The four supplies furnish regulated voltages of -150 volts, +100 volts, +225 volts and +350 volts. The +225-volt supply also has an unregulated output of about +360 volts for the oscillator tube in the high-voltage supply for the crt. It is unnecessary to regulate this supply as the high-voltage power supplies have their own regulation circuits. The time-delay relay K601 remains open for about thirty seconds after the power switch has been turned on. This prevents the application of any dc voltages to the amplifier tubes in the instrument until the temperature of the tube heaters has been brought up to a point sufficient to produce cathode emission.

Reference voltage for the -150-volt supply is established by a gas diode Voltage-Reference Tube V689. This tube, which has a constant voltage drop, establishes a fixed poten-

tial of about -84 volts at the grid of V696B, one-half of a difference amplifier. The grid potential for the other half of the difference amplifier, V696A, is obtained from a voltage divider consisting of R696, R697 and R698. R697, the -150 ADJ., determines the percentage of total voltage that appears at the grid of V696A and thus determines the total voltage across the divider. This control is adjusted so that the output voltage is exactly -150 volts.

Should the loading on the supply tend to change the output voltage, the potential at the grid of V696A will change in proportion, and an error voltage will exist between the two grids of V696. The error signal is amplified and appears at the grid of the amplifier V674. The error signal is again amplified in V674 and is coupled to the grids of the series tube V687 by the neon lamps B681 and B682. There is no attenuation in the neon lamps; they are simply used to set the dc level at the grids of V687. The error voltage appearing at the grids of the series tube will change the voltage drop across the tube and hence change the voltage at the plates of the tube. This change in voltage at the plates of the series tube, which will be a direction to compensate for the change in the output voltage, is coupled through C628 to the output and pulls the output voltage back to its established value of -150 volts. C695 improves the ac gain of the feedback loop and increases the response of the circuit to sudden changes in output voltage.

The -150-volt supply serves as a reference for the +100-volt supply. The voltage divider R663-R664 establishes a voltage of essentially zero at the grid of the amplifier V656 (the actual voltage at this grid is equal to the bias required by the tube). If the loading should tend to change the output voltage, an error voltage will appear at the grid of V656. The error signal will be amplified and will appear at the grid of the series tube V617A. The cathode of V617A will follow the grid, and thus the output voltage will be returned to its established value of +100 volts. C662 improves the response of the regulator circuit to sudden changes in output voltage.

A small sample of the unregulated-bus-ripple will appear at the screen of V656 through R656. This ripple signal appearing at the screen (which acts as an injector grid) will produce a ripple component at the grid of V617A which will be opposite in polarity to the ripple appearing at the plate of V617A. This tends to cancel the ripple at the cathode of V617A, and hence reduces the ripple on the +100-volt bus. This same circuit also improves the regulation of the circuit in the presence of line voltage variations.

The +100-volt regulator, through R667 and R668, provides 75 volts at 150 milliamperes, dc, for the tube heaters in both Plug-In Units. The total heater current (300 milliamperes) activates the relay K668 and removes the shunt R669 from the circuit. If either Plug-In Unit is removed from the instrument, however, the relay closes and R669 is connected into the circuit to maintain the regulation of the +100-volt supply.

Rectified voltage from terminals 7 and 14 of the power transformer is added to the voltage supplying the +100-volt regulator to supply power for the +225-volt regulator. With the -150-volt supply serving as the reference for the +225-volt regulator, the divider R648-R649 establishes a voltage of essentially zero at the grid of V646B, one-half of a differ-



ence amplifier. If the loading should tend to change the output voltage, the error signal will be amplified by the difference amplifier and will appear at the grid of the amplifier V634. The signal will be amplified and reversed in polarity by V634, and will appear at the grids of the series tube V637. The cathodes of the series tubes will follow the grids, and thus the output voltage will be pulled back to its established value of +225 volts. C647 improves the response of the regulator circuit to sudden changes in output voltage. The ripple-cancellation circuitry in the +225-volt supply functions the same as that described for the +100-volt supply.

As mentioned previously, the +225 volt regulator also provided an unregulated output of about +360 volts for the high-voltage supply for the crt.

Rectified voltage from terminals 5 and 10 of the power transformer is added to the voltage supplying the +225-volt regulator to furnish power for the +350-volt supply. This circuit operates in the same manner as the +100-volt regulator; for this reason no further description of the +350-volt regulator is necessary.

### CRT Circuit

A single 60-Kc Oscillator circuit furnishes energy for the three separate power supplies that provide accelerating voltages for the crt. The Oscillator is the Hartley type, whose main components are V800 and the primary of T801 tuned by C806.

The rectifier circuits are the half-wave type, with capacitor-input filters. Separate supplies are required for the cathode and grid circuits in order to supply dc-coupled unblanking to the grid supply when a Time-Base Generator Plug-In Unit is used to sweep the crt horizontally.

V822 supplies —800 volts for the cathode of the crt. V832 supplies +3200 volts for the post-anode acceleration. This provides an accelerating voltage of 4000 volts for the crt beam. V842 supplies about —920 volts for the grid of the crt (the actual voltage depends on the setting of the INTENSITY control R831).

In order to maintain a constant deflection sensitivity in the crt, and thereby maintain the calibration of the oscilloscope, it is necessary that the accelerating potentials in the crt remain constant. This is accomplished by regulating the three supplies, by comparing a "sample" of the high voltage to the regulated —150-volt supply. This "sample," applied to the grid of V816A, is obtained from a divider which is connected between the —800-volt supply and the regulated +225-volt supply. The HV ADJ. R811 determines the percentage of total voltage that appears at the grid of V816A and thus determines the total voltage across the divider. When this control is properly adjusted, the output voltage will be exactly —800 volts.

If the —800-volt supply should tend to drift, an error signal will appear at the grid of V816A, since the cathode of

this tube is connected to the —150-volt regulated supply. The error signal will be amplified by V816A and V816B; the output of V816B varies the screen voltage of the oscillator tube, thereby controlling its output.

### Unblanking

DC-coupled unblanking (when a Time-Base Generator Plug-In Unit is employed in the horizontal deflection circuit) is accomplished by employing separate high-voltage supplies for the grid and cathode. The cathode supply is tied to the +225-volt regulated supply, and therefore cannot be "moved". The grid supply, on the other hand, is not tied to any other supply and is "floating". The unblanking pulses from the Time-Base Generator are transmitted to the grid of the crt via the Unblanking C.F. V843 and the floating grid supply.

The stray capacitance in the circuit makes it difficult to move the floating supply fast enough to unblank the crt in the required time. To overcome this, an isolation network composed of C835, R835 and R836 is employed. By this arrangement, the fast leading edge of the unblanking pulse is coupled directly to the grid of the crt via C835. For short-duration blanking pulses (at the faster sweep rates) the power supply itself is not appreciably moved. For longer unblanking pulses (at slower sweep rates), however, the stray capacitance of the circuit is charged through R835. This holds the grid at the unblanked potential for the duration of the unblanking pulse.

### Calibrator

The calibrator is a square-wave generator whose approximately 1-kc output is available at a front-panel jack labeled CAL. OUT. It consists of a Multivibrator V555A-V565, connected so as to switch the cathode follower V555B between two operating states—cutoff and conduction.

During the negative portion of the Multivibrator waveform, the grid of V555B is driven well below cutoff and the cathode rests at ground potential. During the positive portion of the waveform the grid rises to slightly less than +100 volts. By means of the CAL. ADJ. control R566, the grid voltage can be adjusted so that the voltage at the CAL. VOLT CHECK jack (cathode) can be set to exactly +100 volts when the red SQUARE-WAVE CALIBRATOR knob is turned to the OFF position.

The Calibrator C.F. has a calibrated, tapped voltage divider for its cathode resistor. This divider is shunted, either completely or partially (depending on the setting of the black SQUARE-WAVE CALIBRATOR knob) by another divider R589-R590. The 1000 to 1 ratio of this divider determines whether the output voltage shall be in volts or in millivolts, depending on the position of the red knob. By means of the black knob, nine calibrated voltages from .2 volts or millivolts to 100 volts or millivolts, peak-to-peak, are available.



## MAINTENANCE

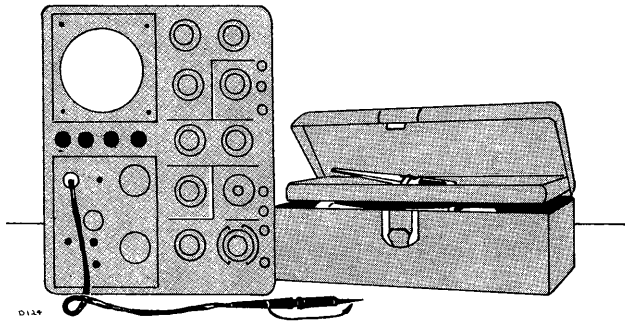

## PREVENTIVE MAINTENANCE

## Recalibration

The Type 536 Oscilloscope is a stable instrument and will provide many hours of trouble-free operation. However, to insure the reliability of measurements obtained on the Type 536, we suggest that its calibration be checked by your Maintenance Department after each 500 hours of operation (or at least every six months if used intermittently). A complete step-by-step procedure for checking the calibration of the instrument is included in the Recalibration Procedure section of this manual.

## Cooling System

The Type 536 is cooled by forced, filtered air. The instrument is equipped with a fan and a washable air filter constructed of aluminum wool coated with an adhesive. If the filter becomes dirty, it may restrict the flow of air and cause the instrument to overheat. The filter should be inspected, and cleaned or replaced if necessary, every three to four months.

To remove the loose dirt, the filter may be rapped gently on a hard surface. It should then be washed with hot soapy water and rinsed thoroughly. After drying, the filter should be coated with "Handi-Coater" or "Filtercoat", products of the Research Products Corp. These products are generally available from air conditioner suppliers.

The bearings in the fan motor should be oiled every three to four months. Use a good grade of light machine oil, and apply only a drop or two.

## Soldering and Ceramic Strips

Many of the components in your Tektronix instrument are mounted on ceramic terminal strips. The notches in these strips are lined with a silver alloy. Repeated use of excessive heat, or use of ordinary tin-lead solder will break down the silver-to-ceramic bond. Occasional use of tin-lead solder will not break the bond if excessive heat is not applied.

If you are responsible for the maintenance of a large number of Tektronix instruments, or if you contemplate frequent parts changes, we recommend that you keep on hand a stock of solder containing about 3% silver. This type of solder is used frequently in printed circuitry and should be

readily available from radio-supply houses. If you prefer, you can order the solder directly from Tektronix in one-pound rolls. Order by Tektronix part number 251-514.

Because of the shape of the terminals on the ceramic strips it is advisable to use a wedge-shaped tip on your soldering iron when you are installing or removing parts from the strips. Fig. 5-1 will show you the correct shape for the tip of the soldering iron. Be sure and file smooth all surfaces of the iron which will be tinned. This prevents solder from building up on rough spots where it will quickly oxidize.

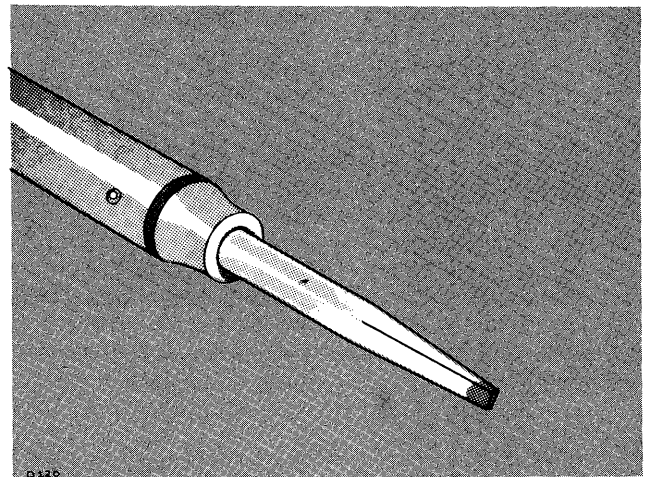

Fig. 5-1. Soldering iron tip properly shaped and tinned.

When removing or replacing components mounted on the ceramic strips you will find that satisfactory results are obtained if you proceed in the manner outlined below.

1. Use a soldering iron of about 75-watt rating.
2. Prepare the tip of the iron as shown in Fig. 5-1.
3. Tin only the first 1/16 to 1/8 inch of the tip. For soldering to ceramic terminal strips tin the iron with solder containing about 3% silver.
4. Apply one corner of the tip to the notch where you wish to solder (see Fig. 5-2).
5. Apply only enough heat to make the solder flow freely.
6. Do not attempt to fill the notch on the strip with solder; instead, apply only enough solder to cover the wires adequately, and to form a slight fillet on the wire as shown in Fig. 5-3.

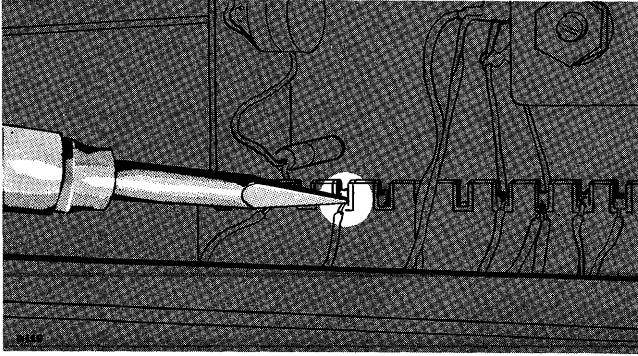

Fig. 5-2. Correct method of applying heat in soldering to a ceramic strip.

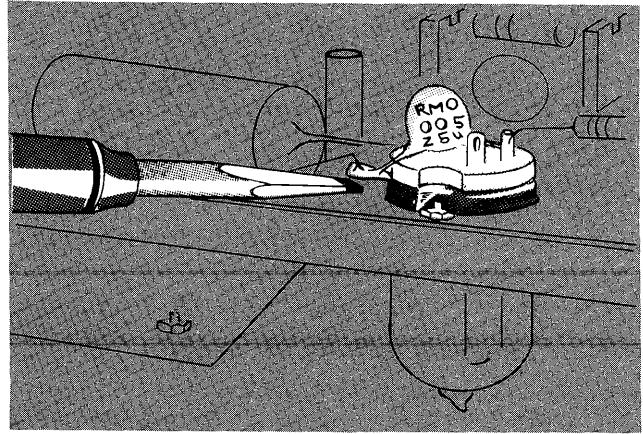

Fig. 5-4. Soldering to a terminal. Note the slight fillet of solder—exaggerated for clarity—formed around the wire.

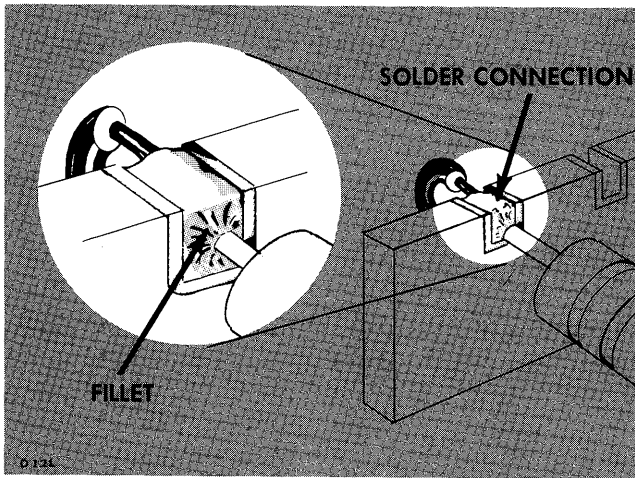

Fig. 5-3. A slight fillet of solder is formed around the wire when heat is applied correctly.

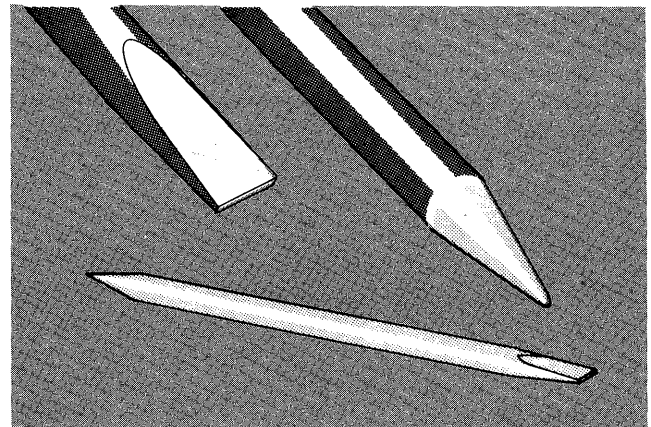

Fig. 5-5. A soldering aid constructed from a 1/4 inch wooden dowel.

In soldering to metal terminals (for example, pins on a tube socket) a slightly different technique should be employed. Prepare the iron as outlined above, but tin with ordinary tin-lead solder. Apply the iron to the part to be soldered as shown in Fig. 5-4. Use only enough heat to allow the solder to flow freely along the wire so that a slight fillet will be formed as shown in Fig. 5-3.

### General Soldering Considerations

When replacing wires in terminal slots clip the ends neatly as close to the solder joint as possible. In clipping the ends of wires take care the end removed does not fly across the room as it is clipped.

Occasionally you will wish to hold a bare wire in place as it is being soldered. A handy device for this purpose is a short length of wooden dowel, with one end shaped as shown in Fig. 5-5. In soldering to terminal pins mounted in plastic rods it is necessary to use some form of "heat sink" to avoid melting the plastic. A pair of long-nosed pliers (see Fig. 5-6) makes a convenient tool for this purpose.

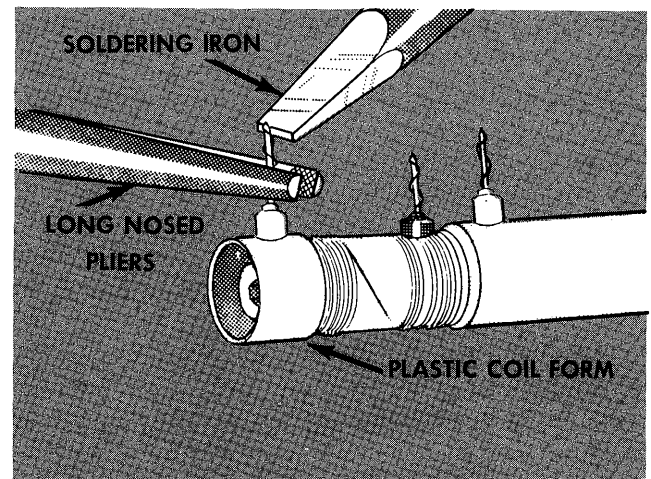

Fig. 5-6. Soldering to a terminal mounted in plastic. Note the use of the long-nosed pliers between the iron and the coil form to absorb the heat.

## Ceramic Strips

Two distinct types of ceramic strips have been used in Tektronix instruments. The earlier type mounted on the chassis by means of #4-40 bolts and nuts. The later type is mounted with snap-in, plastic fittings. Both styles are shown in Fig. 5-7.

To replace ceramic strips which bolt to the chassis, screw a #4-40 nut onto each mounting bolt, positioning the bolt so that the distance between the bottom of the bolt and the bottom of the ceramic strip equals the height at which you wish to mount the strip above the chassis. Secure the nuts to the bolts with a drop of red glyptal. Insert the bolts through the holes in the chassis where the original strip was mounted, placing a #4-40 lockwasher between each nut and the chassis. Place a second set of #4-40 lockwashers on the protruding ends of the bolts, and fasten them firmly with another set of #4-40 nuts. Place a drop of red glyptal over each of the second set of nuts after fastening.

## Mounting Later Ceramic Strips

To replace strips which mount with snap-in plastic fittings, first remove the original fittings from the chassis. Assemble the mounting post on the ceramic strip. Insert the nylon collar into the mounting holes in the chassis. Carefully force the mounting post into the nylon collars. Snip off the portion of the mounting post which protrudes below the nylon collar on the reverse side of the chassis.

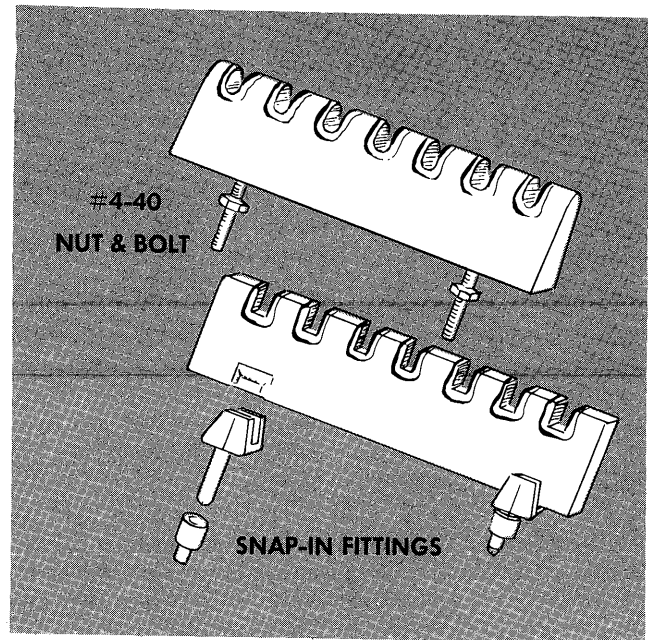

Fig. 5-7. Two types of ceramic strip mountings.

### NOTE

Considerable force may be necessary to push the mounting rods into the nylon collars. Be sure that you apply this force to the upper ends of the mounting rods rather than to the ceramic strip.

## TROUBLESHOOTING PROCEDURE

### GENERAL INFORMATION

### Introduction

This section of the manual contains information for troubleshooting the Type 536 Oscilloscope. Before attempting to troubleshoot the instrument, however, make sure that any apparent trouble is actually due to a malfunction within the oscilloscope, and not due to improper control settings or to a faulty plug-in unit. Instructions for the operation of the Type 536 and certain types of plug-in units are given in the Operating Instructions section of this manual; operating instructions for a specific type of plug-in unit will be found in the manual for that specific unit.

To determine that the oscilloscope is at fault, the plug-in units may be replaced with others known to be in good operating condition. If the trouble is still apparent, it is almost a certainty that the Type 536 itself is at fault. However, should the trouble appear to have been corrected, when the plug-ins were replaced, the trouble most likely lies within one of the original plug-in units and not in the Type 536.

### Tube Failure

Tube failure is the most prevalent cause of circuit failure. For this reason, the first step in troubleshooting any circuit in the Type 536 is to check for defective tubes, preferably by direct substitution. Do not depend on tube testers to adequately indicate the suitability of a tube for certain positions within the instrument. The criterion for usability of a tube is whether or not it works satisfactorily within the instrument. Be sure to return any tubes found to be good to their original socket; if this procedure is followed less recalibration of the instrument will be required upon completion of the servicing.

If replacement of a defective tube does not correct the trouble, then check that components through which the tube draws current have not been damaged. Shorted tubes will sometimes overload and damage plate-load and cathode resistors. These components can often be located by a visual inspection of the circuit. If no damaged components are apparent, however, it will be necessary to make measurements or other checks within the circuit to locate the trouble.



## Component Numbers

The component number of each resistor, inductor, capacitor, vacuum tube, control and switch is shown on the circuit diagrams. The following chart lists the component numbers associated with each circuit.

All 200 numbers	Horizontal Amplifier
All 300 numbers	Vertical Amplifier
All 500 numbers	Calibrator
All 600 numbers	Low-Voltage Power Supply
All 700 numbers	Decoupling Networks for Plug-In Units
All 800 numbers	CRT Circuit

## Faulty-Circuit Isolation

Although the Type 536 is a complex instrument, it can be thought of as consisting of four main circuits, in addition to the Square-Wave Calibrator circuit. These four circuits are the Low-Voltage Power Supply, the CRT Circuit including the High-Voltage Power Supply, the Vertical Amplifier and the Horizontal Amplifier.

The first circuit to check, for practically any type of trouble, is the Low-Voltage Power Supply. Due to the circuit configuration employed in the Type 536, it is possible for an improper power-supply voltage to affect one circuit more than the others. For example, if the gain of the Vertical Amplifier should change, this could be due to an improper power-supply voltage and not to any condition in the Vertical Amplifier. In cases of this type valuable time can be saved by checking the power supplies first.

On the other hand, the crt display can often be used to isolate trouble to one particular circuit when trouble obviously exists in that circuit. If there is no vertical deflection, for example, when the intensity and horizontal deflection appear to be normal, it is apparent that an open condition exists in the Vertical Amplifier and this circuit should be investigated first.

The material that follows contains information for troubleshooting each circuit for troubles that may be caused by a defect in the circuit. A method is described, in some instances, for locating the stage in which the trouble may be originating; once the stage at fault is known, the component(s) causing the trouble can be located by voltage and resistance measurements or by component substitution. In certain other instances the information is more specific and the trouble can be traced to a particular component.

## LOW-VOLTAGE POWER SUPPLY

Proper operation of every circuit in the Type 536, including the plug-in units, depends on proper operation of the Low-Voltage Power Supply. The regulated dc voltages must remain within their specified tolerances for the instrument and the plug-in units to retain their calibration in the vertical- and horizontal-deflection circuits.

### CAUTION

Exercise care in checking the power supply. Because of the current capabilities of the circuit, the Low-Voltage Power Supply can produce more harmful shocks than the high-voltage supply in the CRT Circuit. If you reach into the instrument for any reason, with the power turned on, do not touch the metal frame with the other hand. If possible, use insulated tools and stand on an insulated surface.

## Open Power Circuit (Dead Circuit)

If the pilot lamp and the fan do not come on when the instrument is turned on, check the source of power and the power cord connections. Check the fuse at the rear of the instrument. If the fuse is blown, replace it with one of the proper value and turn the instrument on again. If the new fuse blows immediately, check the power transformer for shorted primary and secondary windings. Also check for shorted power supply rectifiers. If a new fuse does not

blow until the time-delay relay has activated, (a "click" can be heard), check for a shorted condition in the regulator circuits and the loading on the supply.

If the fuse is good, check for an open primary winding in the power transformer. If your instrument is wired for 234-volt operation, check for an open Thermal Cutout switch; the resistance of this switch is about  $.1\Omega$ . (If your instrument is wired for 117-volt operation the fan will come on even though the Thermal Cutout may be open). The Thermal Cutout switch is located toward the rear of the instrument near the fan and the power transformer.

If both the fan and the pilot lamp come on the primary circuit of the power transformer is operating normally.

## Incorrect Output Voltage

The regulated supply voltages, which may be measured at the points indicated in Fig. 5-8, are identified by color-coded wires. The  $-150$ -volt bus is coded brown, green and brown on a black wire; the  $+100$ -volt bus is coded brown, black and brown on a white wire; the  $+225$ -volt bus is coded red, red and brown on a white wire; and the  $+350$ -volt bus is coded orange, green and brown on a white wire.

If any of the supplies fail to regulate the first thing to check is the line voltage. The supplies are designed to regulate between 105 and 125 volts with the design center at 117 volts, or between 210 and 250 volts with the design center at 234 volts, rms.

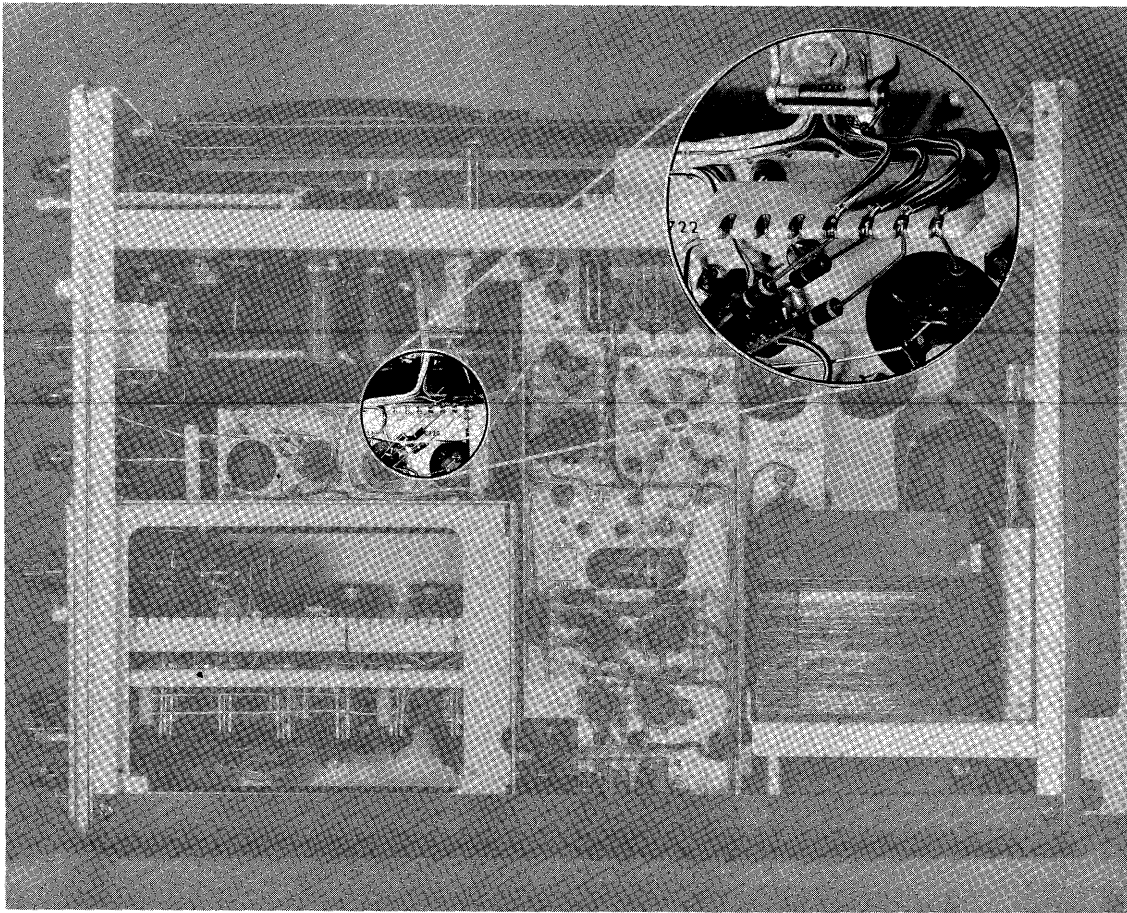

Fig. 5-8. Voltage check points for Low-Voltage Power Supply.

If the line voltage is the correct value, the next step is to remove the plug-in units and measure the resistance between each of the regulated buses and ground. The  $-150$ -volt bus should measure about 20,000 ohms, the  $+100$ -volt bus should measure about 650 ohms, the  $+225$ -volt bus should measure about 15,000 ohms, and the  $+350$ -volt bus should measure about 23,000 ohms, all to ground.

If the resistance values between the regulated buses and ground check out, the next step is to check the tubes (if this has not already been done). Then make sure that the line voltage is set to the design center for your instrument (117 v or 234 v) and check the rms voltage across each secondary winding of the power transformer; the nominal value of each secondary voltage when the line is set to the design center voltage is indicated on the circuit diagram. If the secondary voltages are all correct, the next step is to check the operation of the power supply rectifiers. This can be easily done by measuring the rectified voltage at the input to each regulator. These values are also indicated on the circuit diagram. Then check for open or leaky capacitors, and for off-value resistors, especially in the dividers.

The material that follows may be used as a quick index for troubleshooting.

If the output voltage is high with excessive ripple, check:

- a. For high line voltage.
- b. The Amplifier tubes V606, V634, V646, V656, V674 and V696.
- c. For insufficient loading.

If the output voltage is high with normal ripple, check:

- a. For proper resistance values in the dividers (R614 and R615, R648 and R649, R663 and R664, and R696, R697 and R698).

If the output voltage is low with excessive ripple, check:

- a. For low line voltage.
- b. The Series tubes V607, V617, V637 and V687.
- c. For excessive loading.
- d. Open or leaky filter capacitors.
- e. Defective rectifiers.

If the output voltage is low with normal ripple, check:

- a. The resistance values in the dividers.
- b. The capacitors across the dividers.

## CRT CIRCUIT

The intensity, focus, geometry and calibration of the crt display depend on the proper operation of the high-voltage supply in the CRT Circuit.

### Incorrect Output Voltage

If no high voltage (or insufficient high voltage) is available from any of the three supplies, the Oscillator circuit (V800) should be checked first. The operation of this circuit can be checked first. The operation of this circuit can be checked by removing the shield from the high-voltage supply and holding a neon lamp in the field of high-voltage transformer, as shown in Fig. 5-9. If the lamp glows, when placed in the field of T801, the Oscillator circuit is operating properly. In this case, the trouble would probably be defective secondary windings. It is unlikely that all three rectifier tubes would be defective.

#### CAUTION

Do not let your hand or body touch the instrument when making this check. Secondary reactions to an otherwise harmless shock might result in a painful injury.

If the neon lamp does not glow when placed in the field of T801, the Oscillator circuit is inoperative. If tube replacement (V800, V816) does not correct the trouble, then check the components associated with this circuit, including the primary and secondary of the transformer.

If the correct output voltage is obtained from at least one of the high-voltage supplies, the Oscillator circuit need not be checked. In this case you can check the rectifier tube and components associated with the inoperative supply (s).

If the high voltage appears to be too high, as evidenced by decreased deflection sensitivity, the regulator circuit V816 should be checked. If this tube or any component in the circuit is changed you should check the setting of the H.V. ADJ. control R811.

### No Spot or Trace Visible on CRT

If the power supply voltages are normal, but no spot or trace is visible on the crt, the trouble could be a defective crt, a defect in the crt circuit, or an unbalanced dc condition in either or both of the deflection amplifiers. In the latter case, the dc unbalance is producing improper positioning voltages and the beam is being deflected off the screen.

To determine which circuit is at fault, set the POSITIONING control on each plug-in unit to the approximate center of its range. Then measure the voltage at each deflection plate (at the neck pins) with respect to ground. If the de-

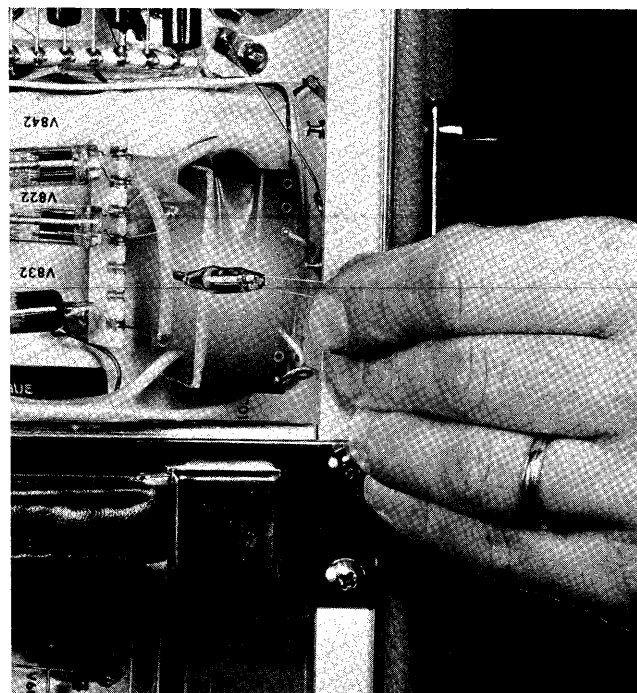

Fig. 5-9. Using a neon lamp to check for energy in the field of the high-voltage transformer.

flexion amplifiers are in balance, these voltages should read about  $+250$  volts  $\pm 25$  volts, depending on the setting of the POSITIONING controls. If the voltage between either set of deflection plates measures more than about 50 volts, the amplifier driving those plates is out of dc balance sufficient to deflect the beam off the screen. In this event refer to the following section on troubleshooting the deflection amplifiers.

If the deflection voltages appear to be normal, the trouble exists somewhere within the crt circuit; it may possibly be the crt itself. Check the continuity of the cathode circuit; check especially to see that R856 is not open. Also check the ASTIGMATISM control and the lead connecting to the crt base; if this circuit is open no trace will be visible on the crt. Check the INTENSITY control circuit; this control should vary the voltage at the grid of the crt between about  $-800$  volts and about  $-900$  volts (be sure to observe polarity on your voltmeter).

If the crt circuit appears to be operating normally, then check for a defective crt, preferably by substitution.

(If a badly distorted spot or trace is visible on the crt, check the GEOM. ADJ. control and its connection to the neck pin on the crt).

## DEFLECTION AMPLIFIERS

The material that follows describes a method for troubleshooting the deflection amplifiers in the Type 536. Since the two amplifiers are almost identical, this material will be applicable to either.

### No Spot or Trace Visible on CRT

For the trace to be visible on the crt, the dc voltage between the deflection plates (either Vertical or Horizontal)

must be less than about 50 volts. This means that the plate-to-plate voltage at the Output Amplifier stage must be less than about 50 volts. If the deflection voltage measures more than 50 volts, when the POSITIONING control is set to the approximate center of its range, the deflection amplifier is sufficiently unbalanced to deflect the beam off the screen.

To obtain positive assurance that the suspected deflection circuit is out of dc balance, short the deflection plates together (either UPPER to LOWER or RIGHT to LEFT) at the proper neck pins. Be extremely careful that you do not short the pins to the metal shield around the crt or to the chassis. If the suspected circuit is the one in which the trouble is originating, the spot or trace will appear in the approximate center of the crt when the deflection plates for that circuit are shorted to each other, provided the POSITIONING control for the other deflection circuit is set to the approximate center of its range.

Having established that one of the deflection amplifiers is responsible for the trouble, the shorting strap can then be moved back, point by point, between correspondingly opposite sides of the circuit. These points would be the grids of the Output Amplifier stage, the cathodes of the Second C.F., the cathodes of the First C.F., the plates of the Input Amplifier, and if necessary the grids of the Input Amplifier. When a point is reached where the trace or spot is no longer visible as opposite sides of the amplifier are shorted together, the stage immediately following this point is one in which the unbalance is being produced. The trouble could be a defective tube, an open peaking coil, a shorted capacitor or a defective resistor.

### Insufficient or No Deflection

Insufficient deflection indicates a change in the gain characteristics of the deflection amplifier concerned. If only a slight change in gain is apparent the amplifier can usually be recalibrated for gain; in this case, refer to the Recalibration Procedure section of the manual.

If the change in gain is more pronounced, or if there is no deflection at all, the tubes should first be checked. Then check for components that can affect the gain but not the dc balance of the circuit. In the Vertical Amplifier, such components would be plate-dropping resistors R303, R305, R328, R341 and R349, the screen resistor R359, the cathode resistors R307, R344 and R353, and the VERT. GAIN ADJ. control R313.

### Waveform Distortion

Any waveform distortion that may be produced by a Type 536 will generally be of a high-frequency nature. There will be no low-frequency distortion since the deflection amplifiers are dc-coupled from input to output (unless one or more of the tubes enter into heavy grid current, a condition that will produce other types of distortion as well).

High-frequency distortion will appear as either a rolloff or an overshoot at the leading corner of a fast-rise step function. An example of rolloff in the case of the Vertical Amplifier is shown in Fig. 5-10(A).

A small amount of rolloff is normally due to a change, with age, in the characteristics of the circuit components, and can usually be compensated by returning the amplifier. If the rolloff is more pronounced, however, the tubes should be checked. If a tube cannot deliver current instantaneously on demand it will not be able to reproduce the transients in the signal.

Shorted or partially shorted peaking coils will result in a rolloff. Be especially careful when soldering around the peaking circuits as hot solder dropping on a peaking coil may burn through the insulation and short the turns.

An overshoot at the leading corner, shown in Fig. 5-10(B), may be the result of an improperly tuned amplifier, or it may be the result of a cathode interface layer in one or more of the tubes. If due to improper tuning it can be tuned out by readjusting the peaking coils; if due to interface it will not respond to tuning and the tube(s) producing the overshoot must be replaced.

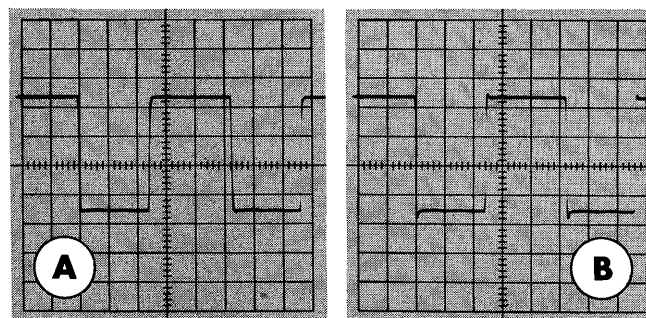

Fig. 5-10. Two types of high-frequency distortion in the Vertical Amplifier: (A) rolloff and (B) overshoot.

## CALIBRATOR

### Asymmetrical Output

If the output square wave is not symmetrical... that is, if the positive portion of the square wave has a duration different from that of the negative portion... the two tubes comprising the multivibrator circuit are not being held cutoff for equal periods. This will normally be due to the tubes themselves, and for this reason the tubes should first be replaced. If tube replacement does not produce a symmetrical waveform, then the circuit components must be checked.

V555A is held cutoff for an interval determined by the discharge of C554, and V565 is held cutoff for an interval determined by the discharge of C558. A change in the value of either capacitor, or in the value of the resistors through which they discharge, could produce an asymmetrical output waveform.

In addition, the time needed for these capacitors to discharge a given amount is affected by the potential toward which they discharge; this would be the voltage at the plate of V555A in the case of C558, and the voltage at the screen

## Maintenance — Type 536

of V565 in the case of C554. Since these voltages are determined, in part, by the value of R550 and R562, respectively, these resistors should be checked. The resistors in the plate circuit of V565 should also be checked, since they will affect the plate-to-screen ratio of V565.

### Incorrect Output Voltage

The amplitude of the output square wave is determined almost entirely by the resistance values of the precision divider in the cathode circuit of V555B. A quick check of the resistance values can be made by turning off the Calibrator

and measuring the voltage at the CAL. VOLT CHECK point; if this point does not measure exactly +100 volts the output voltages (when the Calibrator is turned on) will not be correct.

The CAL. ADJ. control R566 will vary the voltage at the cathode of V555B (the CAL. VOLT CHECK) over about a 10-volt range. If the cathode voltage cannot be set to exactly +100 volts with this control, and if the tubes have been replaced, then one or more of the precision resistors in the divider have changed in value.

A thousand to one divider R589-R590 determines whether the output voltage is in volts or millivolts. These resistors should be checked if the circuit fails to divide properly.

# CALIBRATION PROCEDURE

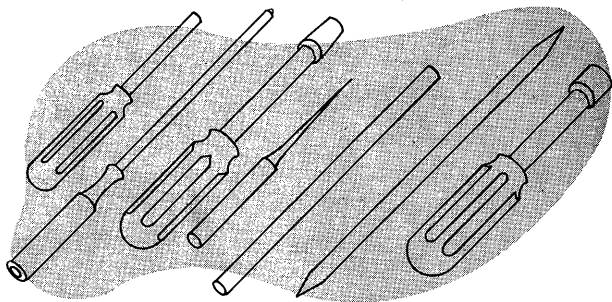

## Introduction

The Type 536 Oscilloscope is a stable instrument, and will normally retain its calibration for long periods of use. To insure the reliability of measurements, however, we suggest that its calibration be checked after each 500 hours of operation, or at least every six months if used intermittently. In addition, the calibration of the circuits affected should be checked whenever a tube or component is changed.

It is not always necessary to check the calibration of the entire instrument, however. Often when a tube or component is changed in a circuit, only one or two adjustments may be necessary to return the instrument to calibration. On the other hand, some circuits (namely the Low-Voltage Power Supply and the High-Voltage Power Supply) affect the calibration of the entire instrument. Before making any adjustments in these circuits be sure to read the instructions carefully; an unnecessary adjustment may require a complete recalibration of the instrument.

The procedure that follows lists the steps for checking the calibration of the entire instrument. Each step contains the information necessary to check the setting of one adjustment. The location of each adjustment can be found by referring to Top View or the Side View pull-out sheets. If the instrument fails to calibrate, in any of these steps, refer to the Troubleshooting Procedure section of this manual.

In checking the calibration of the Type 536, it is convenient to divide the instrument into three main sections: (1) The Power Supply, CRT and Calibrator Circuits; (2) The Vertical Deflection Amplifier; and (3) The Horizontal Deflection Amplifier. With the exception of the power supplies (as mentioned previously), adjustments in one section will normally not affect the calibration of other sections. In some instances, however, there is interaction between control adjustments made in the same section of the instrument. If it is necessary to adjust any of these controls, some steps may have to be repeated two or three times to obtain proper calibration. This effect will be described at the appropriate time in the instructions that follow.

## Equipment Required

The following equipment is necessary to check the complete calibration of the Type 536 Oscilloscope.

1. Two identical, properly calibrated Tektronix "Fast-Rise" or "Wide-Band" Plug-In Preamplifier Units, preferably the Type K or the Type L. If neither of these types is available, a pair of the following types may be substituted: Type A, Type B, Type C or Type H.

2. One Tektronix Type T Time-Base Generator Plug-In Unit.
  3. DC voltmeter (sensitivity at least 5000 ohms/volt) calibrated for an accuracy of  $\pm 1\%$  at 150 volts and  $\pm 3\%$  at 800 volts. Be sure your meter is accurate; an inaccurate voltage reading may adversely affect the calibration of the entire instrument.
  4. Accurate rms-reading ac voltmeter, 0-125 volts (0-250 volts for 234-volt operation).
  5. Variable autotransformer (Powerstat, Variac, etc.) having a rating of at least 6.5 amperes.
  6. Square-Wave Generator, Tektronix Type 105 or equivalent. Accessories required: 1-Type B52-R Terminating Resistor, 1-Type B52-L10 Pad (20 db.), 1-Type P52 Coaxial Cable.
- The square-wave generator required must have the following specifications: (1) output frequencies of 50 Kc, 100 Kc, and 400 Kc; (2) output amplitude of about 250 millivolts; and (3) risetime no more than 20 millimicroseconds (when properly terminated).
7. Constant-Amplitude Signal Generator, Tektronix Type 190, Type 190A, or equivalent. Accessories required: 1-Type M-358 Amphenol "T" Adapter, 1-Type PL-258 Amphenol Straight Adapter, and 2-Type P93 Coaxial Cables (equal length).
  8. Alignment tools (see Fig. 6-1).

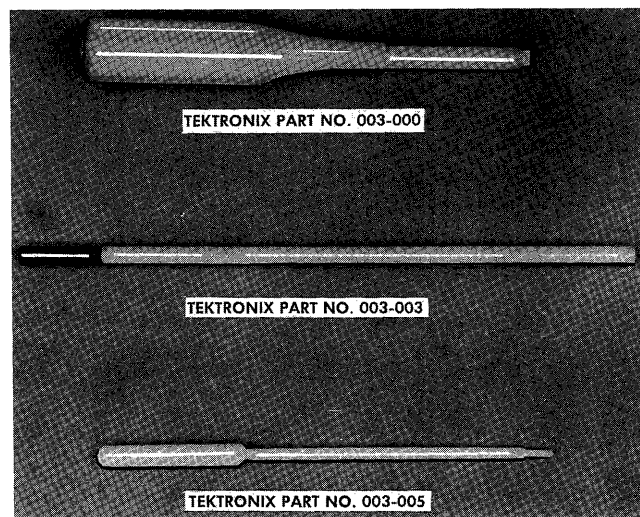

Fig. 6-1. Alignment tools required to recalibrate the Type 536 Oscilloscope.



## POWER SUPPLY AND CRT CALIBRATOR CIRCUITS

This section contains the information for checking the calibration of the power supplies, the calibrator, and the crt circuits. There are two control adjustments described in this section that will affect the calibration for the entire instrument; these are the adjustments that set the -150 volts in the low-voltage power supply, and the -800 volts in the high-voltage power supply. Do not adjust either of these controls if the voltages measure within their indicated limits (be sure your meter is accurate).

### 1. Preliminary

Install the Type T Time-Base Generator Plug-In Unit into the HORIZONTAL section of the Type 536 Oscilloscope, and install the Type K (or other type preamplifier) Plug-In Unit into the VERTICAL section. Remove the two side covers from the instrument and set the front-panel controls as follows:

Type 536:

INTENSITY MODULATION	INT. UNBLANK
SQUARE-WAVE CALIBRATOR	OFF
POWER	OFF

Type T Plug-In Unit:

TRIGGER MODE	AUTO
TRIGGER SLOPE	+EXT.
5X MAGNIFIER	OFF
TIME/DIV.	.5 MILLI SEC
VARIABLE	CALIBRATED (full right)

Preamplifier Plug-In Unit:

The controls listed below are those associated with the Type K Plug-In Unit. The nomenclature will differ slightly with other types of plug-in units.

AC DC	DC
VOLTS/CM	.05
VARIABLE	CALIBRATED (full right)

Note: For those controls not listed, either their adjustments will be described in the procedure that follows, or their setting is not pertinent to this part of the procedure.

Connect the Type 536 to the autotransformer, adjust the output of the autotransformer for approximately 117 volts (234 volts if your instrument is connected for this type of operation), and turn the POWER switch on the Type 536 to the ON position. After a couple of minutes for warmup, recheck the output of the autotransformer for exactly 117 volts (or 234 volts).

### 2. Low-Voltage Power Supply

Proper operation of the Type 536 Oscilloscope, including the two plug-in units is dependent on correct power supply

voltages. The -150-volt regulated supply serves as the reference for the other regulated supplies. This voltage is critical; it must measure within 2 percent of its rated value.

Connect the voltmeter between the -150-volt checkpoint (see Fig. 6-8) and the chassis. If the voltage measures between -147 volts and -153 volts, the supply is within tolerance and no adjustment is necessary. If the voltage does not measure within these limits, however, adjust the -150 ADJ. control R697 until the voltage measures -150 volts. To check the regulation of the -150-volt supply, vary the output voltage of the autotransformer from 105 volts to 125 volts (from 210 to 250 volts if the instrument is connected for this type of operation); the output of the -150-volt supply should remain constant over this range of input voltages.

The voltages of the three other regulated supplies can also be measured at the point indicated in Fig. 6-8. These supplies must regulate to within 3 percent of their rated value. The +100-volt supply should measure  $100 \pm 3$  volts, the +225-volt supply should measure  $225 \pm 6$  volts, and the +350-volt supply should measure  $350 \pm 10$  volts. The regulation of these supplies can be checked by varying the autotransformer between 105 and 125 volts (or 210 to 250 volts); the voltages should remain constant over this range.

If any of the supplies fail to regulate within the specified tolerances, refer to the Troubleshooting Procedure of this manual.

### 3. Square-Wave Calibrator

The amplitude of the output voltage of the Square-Wave Calibrator is dependent on the quiescent cathode voltage of the Calibrator C.F. V555B. When the cathode voltage is +100 volts, the output voltage at the CAL. OUT connector will be within 3 percent of the front-panel calibration.

To check this voltage, leave the front-panel controls unchanged from Step 1 (make sure the red CALIBRATOR knob is set to the OFF position), and connect the voltmeter between the CAL. VOLT. CHECK test point and ground. If this voltage does not measure +100 volts, adjust the CAL. ADJ. control R566 to obtain this voltage.

If the Calibrator Multivibrator circuit is operating symmetrically, the voltage at the CAL. VOLT. CHECK test point will fall to 50 volts  $\pm 5$  volts when the red CALIBRATOR knob is turned to either the MILLIVOLTS or VOLTS position. Nonsymmetrical operation of the Multivibrator is usually caused by a defective tube (V555A-V565).

### 4. High-Voltage Power Supply

The adjustment that sets the high voltage determines the total accelerating voltage on the crt and thus affects the deflection sensitivity. To check the setting of this adjustment, connect the voltmeter between the H.V. ADJ. TEST PT and the chassis. The voltage at this point should measure  $-800 \pm 25$  volts (be sure to set your voltmeter on the proper scale and observe polarity). If the voltage measures within

these limits no adjustment of the circuit is necessary. If the voltage does not measure within 25 volts of  $-800$  volts, however, adjust the H.V. ADJ. R811 for a reading of  $-800$  volts.

During the check for regulation, the output of the  $-800$ -volt supply should not vary more than 10 volts between the following limits.

For 117-volt operation—

Lower limit: Line voltage 105 volts;  
INTENSITY control turned full right.

Upper limit: Line voltage 125 volts;  
INTENSITY control turned full left.

For 234-volt operation—

Lower limit: Line voltage 210 volts;  
INTENSITY control turned full right.

Upper limit: Line voltage 250 volts;  
INTENSITY control turned full left.

## 5. CRT Alignment

To check the alignment of the crt, obtain a clear, sharp trace on the crt. If the front-panel controls have not been changed since Step 1, you should need only to adjust the INTENSITY, FOCUS and ASTIGMATISM controls to obtain the trace. Next, adjust the POSITIONING control on the Vertical plug-in unit until the trace is positioned directly behind the center graticule line (adjust the SCALE ILLUM. control for the level most pleasing to your eyes). If the trace and the graticule line coincide over the entire length of the graticule, the crt is properly aligned and no ad-

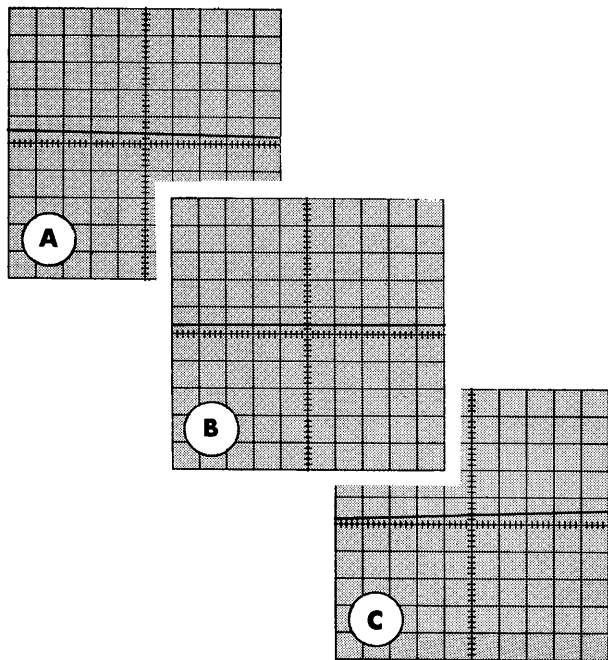

Fig. 6-2. Checking the alignment of the crt.

justment is necessary. If the two do not coincide, however, it will be necessary to loosen the crt base clamp and rotate the tube by means of the nylon adjusting ring until they do. (See Fig. 6-2). After you have aligned the crt trace with the graticule line, push the crt forward until it rests snugly against the graticule and tighten the base clamp. Recheck the alignment of the crt after tightening the clamp to be sure it didn't move while the clamp was being tightened.

## 6. CRT Geometry

With the controls unchanged from the preceding step, position the trace to the top line of the graticule. For the crt to be within its specifications for geometry, any deviation from a straight, horizontal trace, at this point, must be less than three-quarters of one minor division. (See Fig. 6-3). If the curvature of the trace exceeds this tolerance, adjust the GEOM. ADJ. control R862 until the trace is most nearly coincident with the top graticule line. (It may be necessary to slightly readjust the FOCUS and ASTIGMATISM controls

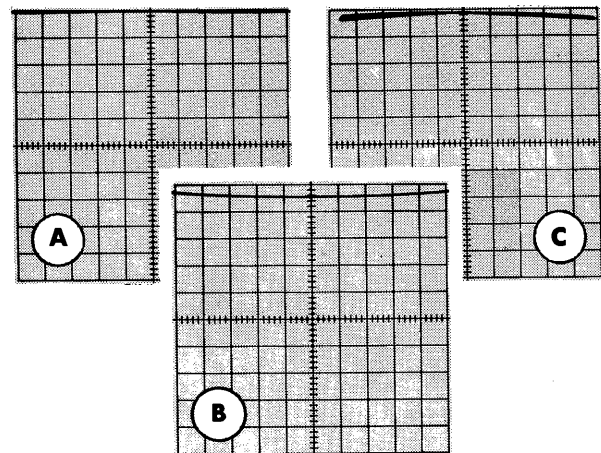

Fig. 6-3. Checking the geometry of the crt.

for this setting of the Vertical POSITIONING control.) Then, position the trace to the bottom line of the graticule and check the geometry. You may find the adjustment for best geometry when the trace is positioned at the top of the graticule may not be the best adjustment when the trace is positioned at the bottom of the graticule. If this situation occurs, work back and forth between the top and bottom of the graticule, and adjust the GEOM. ADJ. control for the best overall linearity.

## VERTICAL DEFLECTION AMPLIFIER

This section contains the information for checking the calibration of the Vertical Deflection Amplifier. There is also one adjustment to check on the Vertical plug-in unit to make the procedure complete.

### Vertical DC Balance

While this is more of an operator's check than a calibration check, the setting of the DC BAL. control on the front panel of the plug-in unit must be checked before proceeding with the Vertical Amplifier.

Set the front-panel controls as outlined in Section (1) (leave the POWER switch ON) and adjust the INTENSITY, FOCUS, ASTIGMATISM and Vertical POSITIONING controls for a trace of suitable intensity and sharpness near the center of the crt. Then rotate the VARIABLE control on the front panel of the Vertical plug-in unit. If there is any vertical displacement to the crt trace, as the VARIABLE control is rotated, the DC BAL. control is improperly adjusted. If this is the case, adjust the DC BAL. control, while continuing to rotate the VARIABLE control, until there is no longer any vertical displacement of the trace.

### 7. Vertical Amplifier Gain

To check the adjustment that sets the gain of the Vertical Amplifier, set the front-panel controls as outlined in Section (1), but leave the POWER switch ON. Connect a jumper from the CAL. OUT connector to the INPUT connector on the Vertical plug-in unit, and connect another jumper from the VERT. SIG. OUT connector to the TRIGGER INPUT connector on the Type T Horizontal plug-in unit. Next, turn the red CALIBRATOR knob to VOLTS and the black CALIBRATOR knob to .2. Then, adjust the INTENSITY, FOCUS and ASTIGMATISM controls until the waveform appearing on the crt has the best presentation. These control settings should result in a display of about five cycles of the calibrator waveform. Center the display on the crt with the POSITIONING controls.

With a fixed-voltage input to the Vertical deflection system from the Calibrator, the amount of deflection on the crt depends on two factors: the gain of the Preamplifier plug-in unit and the gain of the Vertical Amplifier. With

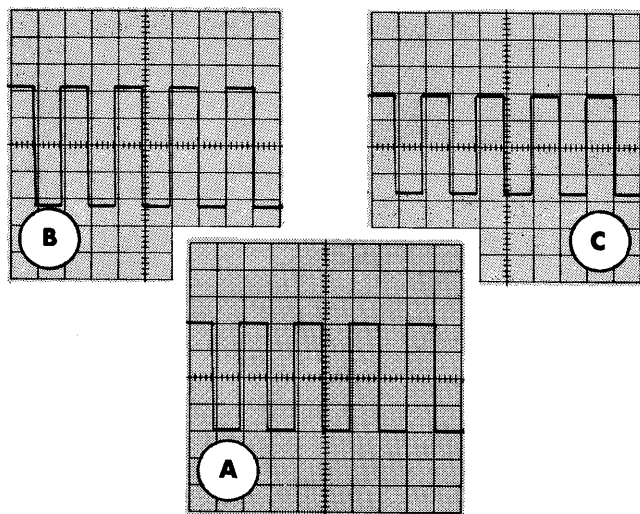

Fig. 6-4. Checking the gain of the vertical amplifier.

the gain of the preamplifier established by its own calibration, any deviation from the front-panel calibration will be due to an improper adjustment of the VERT. GAIN ADJ. control in the Type 536.

Make sure the VOLTS/CM switch on the Vertical plug-in unit is set to .05 and the VARIABLE control is set to the CALIBRATED position. The amount of deflection on the crt should be exactly 4 major divisions. If this amount of deflection is not indicated, adjust the VERT. GAIN ADJ. control R313 until the deflection is exactly 4 major divisions (See Fig. 6-4).

### 8. Vertical Compression and Expansions

With exactly four major divisions of deflection, in the center of the crt, position the top of the waveform to the top line of the graticule. Make sure that the VARIABLE control on the Vertical plug-in remains in the CALIBRATED position. Then check the amount of vertical deflection for this position of the waveform. To be within specifications, the deflection must be 4 major divisions  $\pm 0.5$  minor division. If the vertical deflection, with the waveform positioned at the top of the graticule, is within specifications, then position the bottom of the waveform to the bottom line of the graticule and repeat the check. Again, the specifications call for 4 major divisions  $\pm 0.5$  minor division.

If there is either expansion (excessive deflection) or compression (insufficient deflection) in either or both positions of the waveform you may find it necessary to replace one or both of the Output Amplifier tubes, V354 and V364.

In Type 536 S/N 101 through 614, expansion or compression may be compensated for by adjusting R539, Screen Volts Adjust Control. However, it should be noted that there is interaction between this control and the VERT. GAIN ADJ. control. If it is necessary to adjust the SCREEN VOLTS ADJ. control it will be necessary to return the trace to the center of the crt and readjust the VERT GAIN ADJ. control. After readjusting the VERT. GAIN ADJ. control, return the trace to both the top and bottom of the graticule and recheck for compression or expansion. It may be necessary to repeat this procedure two or three times to obtain the proper adjustment of both controls.

### 9. Vertical Beam Position Centering

Set the front-panel controls as outlined in Section (1) (leave the POWER switch ON) and adjust the INTENSITY, FOCUS and ASTIGMATISM controls for sharp trace on the crt. Position the trace in the exact center of the crt and observe the Vertical Beam Position Indicators (the two small neon lamps above the left corner of the graticule cover). Both lamps should be extinguished when the trace is in the exact center of the graticule. If either lamp is lighted, adjust the BEAM POSITION INDICATOR CENTERING control R375 until the lamp is extinguished. Then move the trace up and down the crt with the Vertical POSITIONING control and adjust the BEAM POSITION INDICATOR CENTERING control until the lamps fire equidistant from the center graticule line.

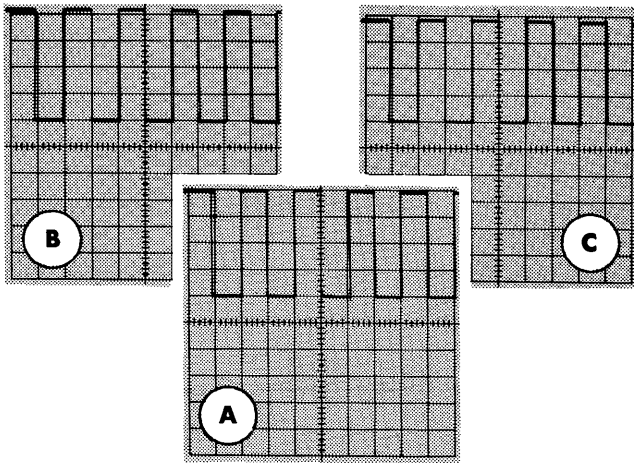

Fig. 6-5. Checking for compression or expansion in the vertical amplifier.

### 10. Vertical Signal Out DC Level

With the controls unchanged from the previous step, position the trace in the exact center of the crt. Next, connect a voltmeter, set to a DC scale, between the VERT. SIG. OUT connector and the chassis. With the trace centered vertically on the crt, the voltage at this connector should read zero. If the voltmeter does not read zero, adjust the VERT. SIG. OUT DC LEVEL ADJ R395 for a zero reading.

### 11. Vertical DC Shift

With a free-running trace in the exact center of the crt (as obtained in the previous step), connect an ohmmeter

between the INPUT connector on the Vertical plug-in unit and the chassis. The voltage at this connector is zero, so there is no danger of damaging your ohmmeter. Set the ohmmeter on the R x 1 scale, and set the VOLTS/CM control to .2. Then adjust the VARIABLE control until the trace is visible either at the top or bottom (depending on the polarity of the battery voltage in the ohmmeter) of the graticule. The setting of the VOLTS/CM control is premised on your ohmmeter using a 1½-volt cell on the R x 1 scale. If the battery in your ohmmeter is such that you cannot obtain the trace at either the top or bottom of the graticule with the VOLTS/CM control set to .2, then set this control to any position where, with the aid of the VARIABLE control, you can obtain the trace at either position. Or, if preferred, a 1½-volt cell can be connected between the INPUT connector and the chassis, in which case the VOLTS/CM and VARIABLE controls can be adjusted as explained previously.

Remove the lead from the INPUT connector and the trace will return to the center of the crt. Now, reconnect the lead to the INPUT connector, and carefully observe the trace as it comes to rest in its new position. If there is more than one-half of one minor division of drift in the vertical position of the trace, as it comes to rest, the DC shift compensation network is incorrectly adjusted. If this is the case, adjust the VERT. DC SHIFT ADJ. control R363 until the vertical drift is within tolerance. It will be necessary to disconnect and reconnect the lead to the INPUT connector several times to properly adjust for DC shift.

### 12. Vertical-Amplifier High-Frequency Compensation

The high-frequency response of the Vertical Amplifier is adjustable, over a limited range, by the variable inductors in the plate circuits of both the Output Amplifier and the Input Amplifier, and by the LR323 time-constant network in the plate circuit of V324.

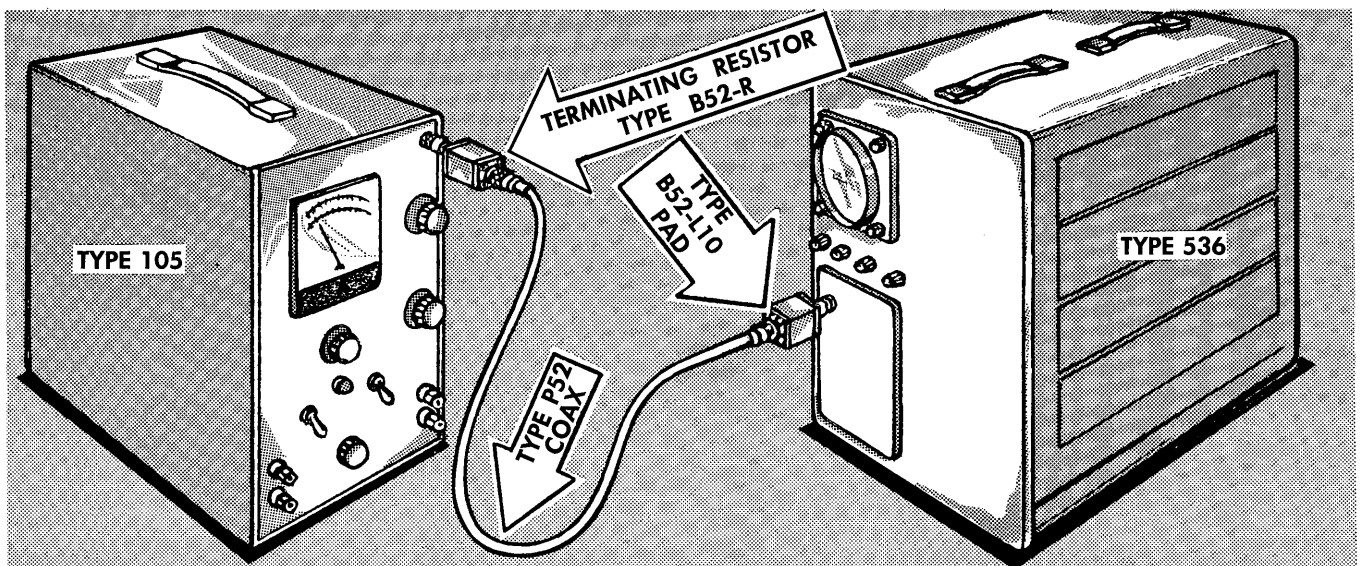

Fig. 6-6. Connecting the Type 105 Square-Wave Generator to the Type 536.

## Calibration Procedure — Type 536

To check the high-frequency response of the Vertical Amplifier, set the front-panel controls as follows:

### Type 536

INTENSITY MODULATION	INT. UNBLANK
SQUARE-WAVE CALIBRATOR	OFF
POWER	ON
AMPLIFIER PHASING	50

### Preamplifier Plug-In Unit (in Vertical section)

AC DC	DC
VOLTS/CM	.05
VARIABLE	CALIBRATED

### Type T Plug-In Unit (in Horizontal section)

TRIGGER MODE	AUTO.
TRIGGER SLOPE	+EXT.
5X MAGNIFIER	OFF
TIME/DIV.	.5 MICRO SEC
VARIABLE	CALIBRATED

Connect a jumper wire between the VERT. SIG. OUT connector and the TRIGGER INPUT connector. Then, connect the Type 105 Square-Wave Generator to the Preamplifier plug-in unit in the manner shown in Fig. 6-6. Make sure that the Type B52-R Terminating Resistor is connected to the OUTPUT connector of the Type 105, and that the Type B52-L10 Pad is connected to the INPUT connector of the Preamplifier plug-in unit. Set the RANGE and FREQUENCY controls on the Type 105 for a frequency of about 400 Kc, and set the OUTPUT AMPLITUDE control for a vertical deflection of about 4 major divisions. Adjust the INTENSITY, FOCUS, ASTIGMATISM and POSITIONING controls for a presentation similar to that shown in Fig. 6-7.

Now, closely examine the leading corner of the positive-going pulse in the center of the crt. If this corner is nice and square, as shown in Fig. 6-7(A), no adjustment of the compensating networks is necessary. However, if there is any rolloff to the corner, as shown in Fig. 6-7(B), or overshoot as shown in Fig. 6-7(C), the Vertical Amplifier is in need of adjustment.

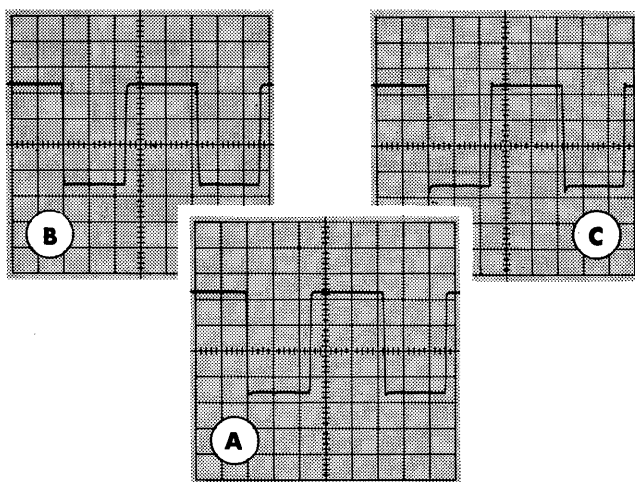

Fig. 6-7. Checking the high-frequency compensation of the vertical amplifier.

If the need for adjustment is indicated, adjust L304 and L324, located above the 12BY7 Input Amplifier tubes, and L350 and L356, located above the 6360 (5894 S/N 101-614) Output Amplifier tubes. Do not adjust LR323 at this time. In normal operation, the top of the slugs, in L304 and L324, should be just about even with the top coil forms. And, about one-quarter inch of the adjusting screws, for L350 and L356, should be visible when these coils are properly adjusted.

To adjust the LR323 network, set the RANGE and FREQUENCY controls of the Type 105 for an output frequency of about 100 kc, and set the TIME/DIV. control on the Type T Plug-In Unit to 2 MICRO SEC. These settings should result in a display similar to that shown in Fig. 6-8. Again, examine the leading corner of the pulse appearing in the center of the crt. If the corner is square, as shown in Fig. 6-8, no adjustment is necessary. However, if there is any rolloff or overshoot, the time constant of this network is incorrect. When this network is properly adjusted, the slug in LR323 will normally be positioned in the coil form for maximum inductance.

## 13. Vertical-Signal Out Waveform Compensation

Proper compensation of the waveform available at the VERT. SIG. OUT connector depends on the impedance values in the divider of which C392 is part. The compensation of the waveform, which depends on the setting of C392, can be checked in two ways. One method is by observing the waveform available at the VERT. SIG. OUT connector on another oscilloscope. The other method involves only the Type 536, using two Preamplifier-type plug-in units. If another oscilloscope is available, one that is in

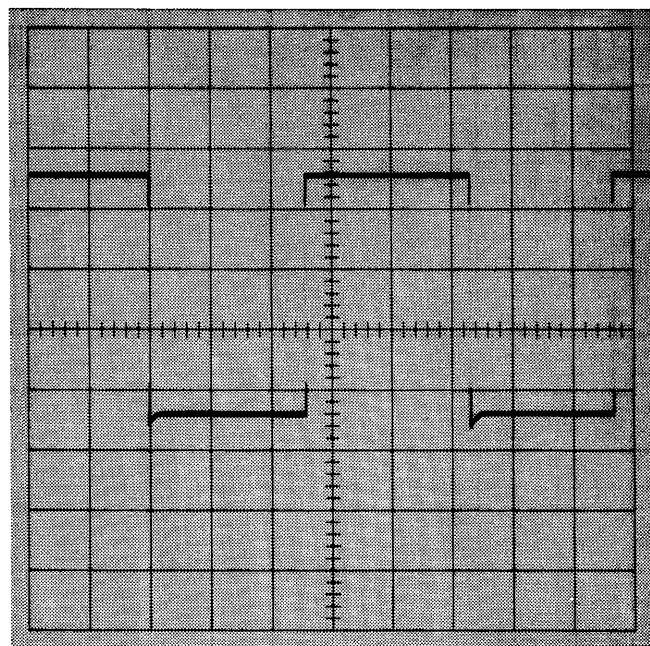

Fig. 6-8. Checking the adjustment of the LR323 network.

good adjustment and properly compensated for high frequencies, the first method is recommended. If another oscilloscope is not available, the second method will yield satisfactory results.

### Method Using Another Oscilloscope

With a Preamplifier-type plug-in unit in the Vertical section, any type of plug-in unit may be used in the Horizontal section. That is, either a Type T or a Preamplifier-type plug-in unit may be used in the Horizontal section. Connect the Type 105 Square-Wave Generator to the INPUT connector of the Vertical plug-in unit in the manner described in Step 12, and set the RANGE and FREQUENCY controls of the Type 105 for an output frequency of about 50 Kc. Adjust the OUTPUT AMPLITUDE control of the Type 105 for a vertical deflection on the Type 536 of about 4 major divisions when the VOLTS/CM and VARIABLE controls are set to .05 and CALIBRATED, respectively.

Connect the probe of the test oscilloscope (make sure the probe has been properly compensated) to the VERT. SIG. OUT connector of the Type 536, adjust the sweep rate of the test oscilloscope for 5 microseconds/division, and adjust the input attenuator for a suitable deflection. These settings should produce a display similar to that shown in Fig. 6-9. If the top and bottom of the waveform are flat, as shown in 6-9(A), no adjustment of the compensating capacitor is necessary. If the waveform appears similar to either Fig. 6-9(B) or 6-9(C), however, the divider is not properly compensated and C392 must be adjusted.

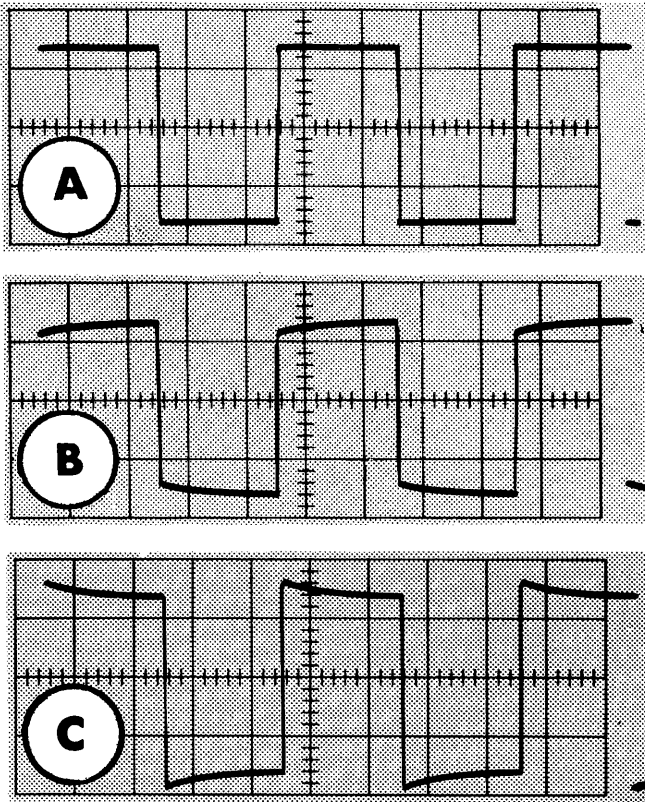

Fig. 6-9. Checking the VERT. SIG. OUT compensation with another oscilloscope.

### Method Using Only the Type 536

With identical Preamplifier plug-in units in the Amplifier sections of the Type 536, adjust the front-panel controls as follows:

Type 536:

INTENSITY MODULATION	INT. UNBLANK
SQUARE-WAVE CALIBRATOR	OFF
POWER	ON
AMPLIFIER PHASING	50

Vertical Plug-In Unit

AC DC	DC
VOLTS/CM	.05
VARIABLE	CALIBRATED

Horizontal Plug-In Unit

AC DC	DC
VOLTS/CM	1
VARIABLE	CALIBRATED

Connect the Type 105 to the INPUT connector of the Vertical plug-in unit, in the manner described previously, and connect a jumper from the VERT. SIG. OUT connector on the Type 536 to the INPUT connector of the Horizontal plug-in unit. Adjust the RANGE and FREQUENCY controls of the Type 105 for an output frequency of about 50 Kc, and adjust the INTENSITY, FOCUS, ASTIGMATISM and POSITIONING controls of the Type 536 for a presentation similar to that shown in Fig. 6-10. Be careful not to set the INTENSITY control any higher than necessary to see the two clearly defined dots on the crt; excessive brilliancy of the display might damage the phosphor on the crt screen.

If two well-defined, sharp spots appear on the crt, as shown in Fig. 6-10(A), the divider is properly compensated. However, if there is either a leading or a trailing smear to the dots, as shown in Fig. 6-10(B), C392 must be adjusted. If any smear is present, be sure this is due to an improper adjustment of C392 and not due to an improper setting of the FOCUS and ASTIGMATISM controls.

### 14. Vertical Amplifier Bandwidth

To check the bandwidth of the Vertical Amplifier, install a Preamplifier-type plug-in unit in the Vertical section of

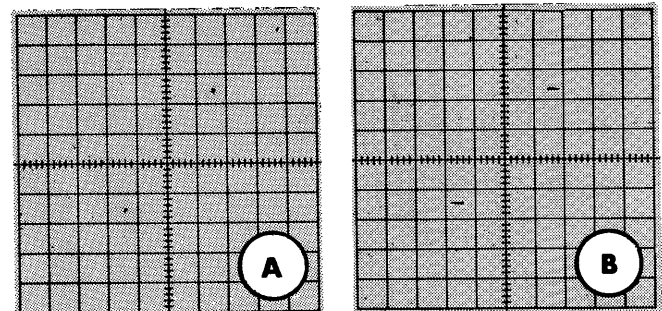

Fig. 6-10. Checking the VERT. SIG. OUT compensation using only the Type 536.



## Calibration Procedure — Type 536

the Type 536, and a Type T Plug-In Unit in the Horizontal section. Set the front-panel controls as follows:

### Type 536

INTENSITY MODULATION	INT. UNBLANK
SQUARE-WAVE CALIBRATOR	OFF
POWER	ON
AMPLIFIER PHASING	50

### Vertical Plug-In Unit

AC DC	DC
VOLTS/CM	*see note below
VARIABLE	CALIBRATED

\*Set the VOLTS/CM control to its most sensitive DC range; this will be .005 on the Type H Plug-In Preamplifier Unit, and .05 on all others listed in (1) of Equipment Required.

### Type T Horizontal Plug-In Unit

TRIGGERING MODE	Any position other than AUTO.
TRIGGER SLOPE	Any position
STABILITY	Full right
TRIGGERING LEVEL	Full right
5X MAGNIFIER	OFF
TIME/DIV.	50 MICRO SEC
VARIABLE	CALIBRATED

Adjust the INTENSITY, FOCUS and ASTIGMATISM controls for free-running trace, and position the trace near the center of the crt. Next, connect the Type 190 or 190A Constant-Amplitude Signal Generator to the INPUT connector of the Vertical plug-in unit, and set the controls on the Signal Generator for an output frequency of 500 Kc. Set the Attenuator of the Type 190 or 190A to .5 (.1 if using a Type H Plug-In Unit), and adjust the OUTPUT AMPLITUDE control for a vertical deflection of exactly 6 major divisions (see Fig. 6-11(A)). Make sure the VOLTS/CM and VARIABLE controls on the Vertical plug-in unit are set to .05 (.005 on the Type H Plug-In Unit only) and CALIBRATED, respectively. You may adjust the Vertical POSITIONING control on the Vertical plug-in unit during this check for bandwidth but do not adjust any other controls.

Next, set the FREQUENCY RANGE switch (Type 190) or the RANGE SELECTOR switch (Type 190A) to the 9.0-21 scale, and adjust the FREQUENCY control (Type 190) or the RANGE IN MEGACYCLES control (Type 190A) until the vertical deflection on the crt falls to exactly 4.25 major divisions, as shown in Fig. 6-11(B). This amount of deflection corresponds to a 3-db drop from the original deflection,

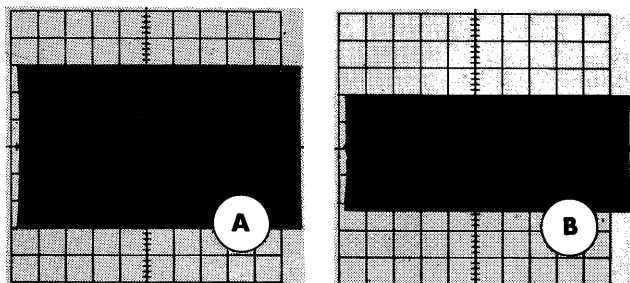

Fig. 6-11. Checking the bandwidth of the vertical amplifier.

and represents the upper-frequency limit of the Vertical Amplifier. This frequency should be at least 12 mc, and typical values are in the range from 13 to 14 mc.

## HORIZONTAL DEFLECTION AMPLIFIER

This section contains the information for checking the calibration of the Horizontal Deflection Amplifier in the Type 536. This procedure is the same as that for checking the calibration of the Vertical Amplifier. For this reason, the information in this section appears in more of an out-line form, and frequent reference is made to the corresponding step in Section (2).

Install the Type T Time-Base Generator Plug-In Unit into the Vertical section of the Type 536, and install the same Preamplifier plug-in unit that was used in Section (2) into the Horizontal section of the Type 536. Set the front-panel controls as follows:

### Type 536

INTENSITY MODULATION	EXT. DC
SQUARE-WAVE CALIBRATOR	
Red Knob	VOLTS
Black Knob	.2
POWER	ON

### Type T Plug-In Unit (in Vertical section)

TRIGGER MODE	AUTO.
TRIGGER SLOPE	+EXT.
5X MAGNIFIER	OFF
TIME/DIV.	.5 MILLI SEC
VARIABLE	CALIBRATED (full right)

### Preamplifier Plug-In Unit (in Horizontal section)

AC DC	DC
VOLTS/CM	.05
VARIABLE	CALIBRATED (full right)

Adjust the INTENSITY, FOCUS and ASTIGMATISM controls for a free-running vertical trace, and then position the trace near the center of the crt.

## 15. Horizontal DC Balance

Rotate the VARIABLE control on the Horizontal plug-in unit. If there is any horizontal displacement of the trace, as this control is rotated, adjust the DC BAL. control until the trace remains stationary.

## 16. Horizontal Amplifier Gain

With the controls unchanged from Step 15, connect a jumper from the CAL. OUT connector to the INPUT connector of the Horizontal plug-in unit, connect another jumper from the HORIZ. SIG. OUT connector to the TRIGGER INPUT connector of the Type T Vertical plug-in unit, and connect a third jumper between the +GATE OUT connector on the Type T Plug-In Unit and the INTENSITY MOD. INPUT connector. This should result in a vertical presentation of the Calibrator waveform on the crt. The horizontal



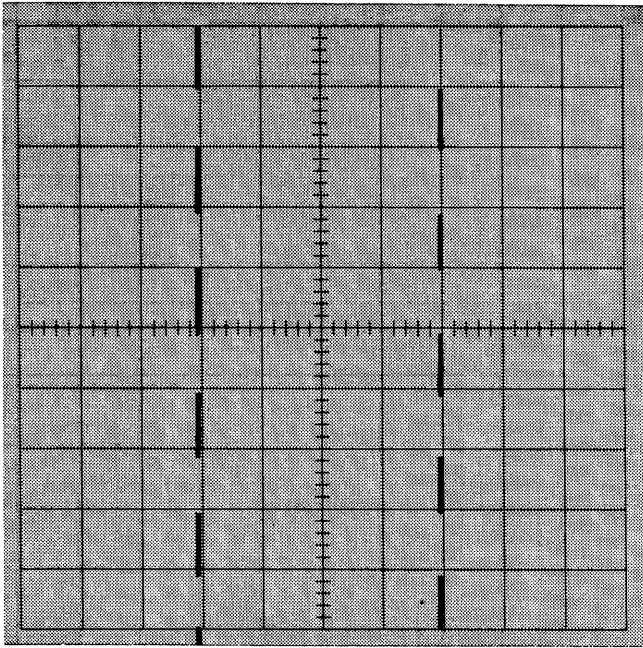

Fig. 6-12. Calibrator waveform displayed on a vertical time-base axis.

deflection should be exactly 4 major divisions, as shown in Fig. 6-12. If it is not exactly 4 major divisions, adjust the GAIN ADJ. control R213 until the deflection is correct.

### 17. Horizontal Compression and Expansion

With exactly 4 major divisions of deflection in the center of the crt, position the left side of the waveform to the left side of the graticule. Check the amount of deflection. To be within specifications, the deflection must be 4 major divisions  $\pm 0.5$  minor division. If the horizontal deflection, with the waveform positioned at the left side of the graticule, is within specifications, then position the right side of the waveform to the right side of the graticule and repeat the check for the same specifications.

If there is either excessive compression or expansion, you may find it necessary to replace one or both Output Amplifier Tubes, V254 and V264.

In Type 536 S/N 101 through 614, horizontal expansion or compression may be corrected for by adjusting the SCREEN VOLTS ADJ. control, R259, following the procedure described in Step 8. Again, it may be necessary to make several readjustments to compensate for interaction between the SCREEN VOLTS ADJ. and GAIN ADJ. controls.

### 18. Horizontal Beam Position Centering

Remove the jumper between the CAL. OUT connector and the INPUT connector of the Horizontal plug-in unit, and position the trace in the exact center of the crt. Next, observe the Horizontal Beam Position Indicator lamps, above

the right corner of the graticule cover. If either lamp is lighted, with the trace in the exact center of the graticule, adjust the BEAM-POSITION INDICATOR CENTERING controls R275 until the lamp is extinguished. Then move the trace from side to side with the Horizontal POSITIONING control and adjust R275 until the lamps fire equidistant from the center of the graticule.

### 19. Horizontal Signal Out DC Level

With the controls unchanged from the previous step, position the trace in the exact center of the crt. Then, connect a voltmeter, set to a DC scale, between the HORIZ. SIG. OUT connector and the chassis. The voltage at this connector should read zero. If the voltmeter does not read zero, adjust the HORIZ. SIG. OUT LEVEL ADJ. R295 for a reading of zero volts.

### 20. Horizontal DC Shift

Connect the ohmmeter, set to the R x 1 scale, between the INPUT connector of the Horizontal plug-in unit and the chassis. Then, following the instructions presented in Step 11, check for DC shift in the Horizontal Amplifier of the Type 536. If any DC shift is indicated (in excess of the tolerance of one-half minor division) adjust the HOR. DC SHIFT COMP. control R263 until the horizontal drift is within tolerance.

### 21. Horizontal-Amplifier High-Frequency Compensation

The high-frequency response of the Horizontal Amplifier is adjustable, over a limited range, in the same manner as that of the Vertical Amplifier.

To check the high-frequency response of the Horizontal Amplifier, set the front-panel controls as follows:

Type 536

INTENSITY MODULATION	EXT. DC
SQUARE-WAVE CALIBRATOR	OFF
POWER	ON
PHASING	50

Type T Plug-In Unit (in Vertical section)

TRIGGER MODE	AUTO.
TRIGGER SLOPE	+EXT.
5X MAGNIFIER	OFF
TIME/DIV.	.5 MICRO SEC
VARIABLE	CALIBRATED

Preamplifier Plug-In Unit (in Horizontal section)

AC DC	DC
VOLTS/CM	.05
VARIABLE	CALIBRATED

Connect a jumper between the HORIZ. SIG. OUT connector and the TRIGGER INPUT connector of the Type T Plug-In Unit, and connect another jumper between the +GATE OUT connector and the INTENSITY MOD. INPUT

## Calibration Procedure — Type 536

connector. Then, connect the Type 105 Square-Wave Generator to the INPUT connector of the Horizontal plug-in unit in the manner described in Step 12 and illustrated in Fig. 6-6. Set the RANGE and FREQUENCY control of the Type 105 for a frequency of about 400 Kc, and set the OUTPUT AMPLITUDE controls for a horizontal deflection of about 4 major divisions. Then adjust the INTENSITY, FOCUS, ASTIGMATISM and POSITIONING controls for a presentation similar to that shown in Fig. 6-13. It is important to note that the direction of the sweep is from the bottom of the crt to the top, and that positive-going portions of the square wave are to the right and negative-going portions are to the left. The leading corner of the square wave, the one with which we are concerned in checking the high-frequency response of the Horizontal Amplifier, is identified in Fig. 6-13.

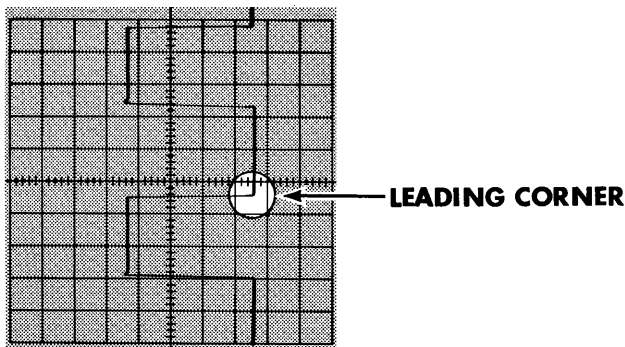

Fig. 6-13. Checking the high-frequency compensation of the horizontal amplifier.

The procedure for checking the leading corner of the square wave, is the same as that explained in Step 12. If there is need to adjust the high-frequency compensation of the Amplifier, L250 and L256 (above V254 and V264), and L204 and L224 (located above V204 and V224, respectively), are adjusted in the manner described in Step 12. However, the slugs of these coils will be positioned slightly deeper into the coil forms than those in the Vertical Amplifier. Like its counterpart in the Vertical Amplifier, the LR223 time-constant network is adjusted at a frequency of about 100 Kc, with the TIME/DIV control set to 2 MICRO SEC.

## 22. Horizontal Signal Out Waveform Compensation

### Method Using Another Oscilloscope

If this method of checking the compensation of the waveform at the HORIZ. SIG. OUT connector is used, make sure that the oscilloscope is in good adjustment, as explained in Step 13.

With the controls of the Type 536 unchanged from the previous step, set the Type 105 Square-Wave Generator for an output frequency of about 50 Kc. Connect a properly compensated probe from the test oscilloscope to the HORIZ.

SIG. OUT connector, and set the sweep rate of the test oscilloscope for 5 microseconds/division. The presentation on the test oscilloscope should appear similar to that shown in Fig. 6-9. If there is any departure from a flat top and bottom on the waveform, adjust C292 to correctly compensate the divider of which it is a part.

### Method Using Only the Type 536

Withdraw the Type T Plug-In Unit from the Vertical section of the Type 536, and install the other Preamplifier Plug-In unit (the same type as in the Horizontal section) in its place. Set the front-panel controls as follows:

#### Type 536

INTENSITY MODULATION	EXT. DC
SQUARE-WAVE CALIBRATOR	OFF
POWER	ON
AMPLIFIER PHASING	50

#### Vertical Plug-In Unit

AC DC	DC
VOLTS/CM	1
VARIABLE	CALIBRATED

#### Horizontal Plug-In Unit

AC DC	DC
VOLTS/CM	.05
VARIABLE	CALIBRATED

Connect the Type 105 Square-Wave Generator to the Horizontal plug-in unit, and connect a jumper from the HORIZ. SIG. OUT connector to the INPUT connector of the Vertical plug-in unit. Set the controls on the Type 105 for an output frequency of about 50 Kc. Adjust the INTENSITY, FOCUS, ASTIGMATISM and POSITIONING controls for a two-dot display similar to that shown in Fig. 6-10. Be sure that the INTENSITY control is not set too high, as excessive spot brilliancy can damage the crt phosphor.

As explained in Step 13, check for any smearing of the spots. However, now any smear will be in an up and down direction, rather than the side to side direction shown in Fig. 6-10. Again, be sure that any smear is actually due to an improper adjustment of C292 and not due to an improper setting of the FOCUS and ASTIGMATISM controls.

## 23. Horizontal Amplifier Bandwidth

Install the Type T Time-Base Unit in the Vertical section of the Type 536, and set the front-panel controls as follows:

#### Type 536

INTENSITY MODULATION	EXT. DC
SQUARE-WAVE CALIBRATOR	OFF
POWER	ON
AMPLIFIER PHASING	50

#### Horizontal Plug-In Unit

AC	DC
VOLTS/CM	*See note below
VARIABLE	CALIBRATED

\*Set the VOLTS/CM control to its most sensitive DC range; this will be .005 on the Type H Preamplifier Plug-In Unit, and .05 on all others listed in (1) of Equipment Required.

Type T Vertical Plug-In Unit

TRIGGERING MODE	Any position other than AUTO.
TRIGGER SLOPE	Any position
STABILITY	full right
TRIGGERING LEVEL	full right
5X MAGNIFIER	OFF
TIME/DIV	50 MICRO SEC
VARIABLE	CALIBRATED

Adjust the oscilloscope controls for a free-running trace, and position the trace near the center of the crt. Next, connect the Type 190 or 190A Constant-Amplitude Signal Generator to the INPUT connector on the Horizontal plug-in unit, and set the controls of the signal generator for an output frequency of 500 Kc. Set the Attenuator of the Type 190 or 190A to .5 (.1 if using a Type H Plug-In Unit), and adjust the OUTPUT AMPLITUDE control for a horizontal deflection of exactly 6 major divisions. Next, following the same procedure outlined in Step 14, adjust the controls of the Signal Generator until the horizontal deflection decreases to 4.25 divisions. Do not touch the OUTPUT AMPLITUDE control of the Signal Generator during this step, and make sure the VOLTS/CM and VARIABLE controls on the Horizontal plug-in unit are set to .05 (.005 on the Type H Plug-In Unit) and CALIBRATED, respectively. The bandwidth of the Horizontal Amplifier should be the same as that of the Vertical Amplifier. That is, it should be at least 12 Mc, and typical values lie in the range from 13 to 14 Mc.

**24. Equalizing the Response of the Deflection Amplifiers**

The bandwidth of both deflection amplifiers depends on the setting of the AMPLIFIER PHASING control. However, because of its configuration, this control will have a greater effect on the bandwidth of the Horizontal Amplifier than on that of the Vertical Amplifier. There should be a setting of the AMPLIFIER PHASING control where the bandwidth of the two deflection amplifiers will be equal.

With the controls unchanged from Step 23, rotate the AMPLIFIER PHASING control and note the change in the bandwidth. If, at some point within the range of this control, the bandwidth of the Horizontal Amplifier is equal to that measured for the Vertical Amplifier, the instrument is within tolerance. If you cannot obtain a bandwidth measurement equal to that obtained for the Vertical Amplifier, however, adjust the capacitor across the deflection plates to change the bandwidth of the circuit affected. In some instruments, this capacitor is C366 and appears across the Vertical deflection plates. In other instruments, this capacitor is C266 and appears across the Horizontal deflection plates. If you find it necessary to adjust this capacitor, you will then have to repeat the steps for adjusting the high-frequency compensation of the amplifiers (Step 12 for the Vertical Amplifier; Step 21 for the Horizontal

Amplifier). This procedure may have to be repeated two or three times to obtain the same 3-db point for both deflection amplifiers. It is important to remember, however, that the greater the capacity of the capacitor across the deflection plates, the lower the possible bandwidth of the circuit in which it is located. This capacitor should therefore be adjusted for as little capacity as possible consistent with equal frequency response for the two deflection amplifiers.

**25. Centering the Amplifier Phasing Control Range**

Install identical Preamplifier plug-in units in both sections of the Type 536, and connect the Type 190 or 190A Constant-Amplitude Signal Generator to the plug-in units in the manner illustrated in Fig. 6-14. Be sure to have equal cable lengths and terminations. Set both plug-in units to their lowest DC range (.005 on the Type H Unit; .05 on all others), and adjust the Signal Generator for an output frequency of 10 Mc. Adjust the OUTPUT AMPLIFIER control for ten divisions of deflection both vertically and horizontally. This should result in a trace extending from the lower left corner of the graticule to the upper right corner, as shown in Fig. 6-15. The trace may either be a closed loop, as shown in Fig. 6-15(A), or an open loop (ellipse) as shown in (B). Rotate the AMPLIFIER PHASING control until the loop is closed; this corresponds to zero degrees phase difference between the two deflection amplifiers. This does not necessarily have to be at 50, the mechanical mid-range of the AMPLIFIER PHASING control. Now, rotate the AMPLIFIER PHASING control and observe the phase shift (opening of the loop) on either side of the zero-phase point. There should be an equal phase shift in either direction. If this is not observed, adjust C254 until an equal loop opening is observed.

**26. Check Amplifier Phasing Range at 10 Mc.**

With the set-up unchanged from Step 25, rotate the AMPLIFIER PHASING control for maximum phase shift in both directions. To be within specifications, the loop must open to at least .87 major division (along either the horizontal or vertical axis), which corresponds to a phase shift of 5 degrees. That is, an opening of at least .87 major division should be obtained on either side of the zero-phase setting of the AMPLIFIER PHASING control.

**27. Check Phase Shift of Deflection Amplifiers**

With the set-up unchanged from the previous step, adjust the AMPLIFIER PHASING control for a phase difference of 1 degree. This will be a loop opening of .17 major division, or just slightly less than one minor division. Now, reduce the frequency of the Signal Generator, in steps, with the Frequency Range switch. The loop should close as the output frequency of the Signal Generator is reduced. If the loop should open, reset the output frequency to 10 Mc, and readjust the AMPLIFIER PHASING control for a 1-degree phase difference in the opposite direction. Then repeat the check for frequencies from 10 mc down toward DC.

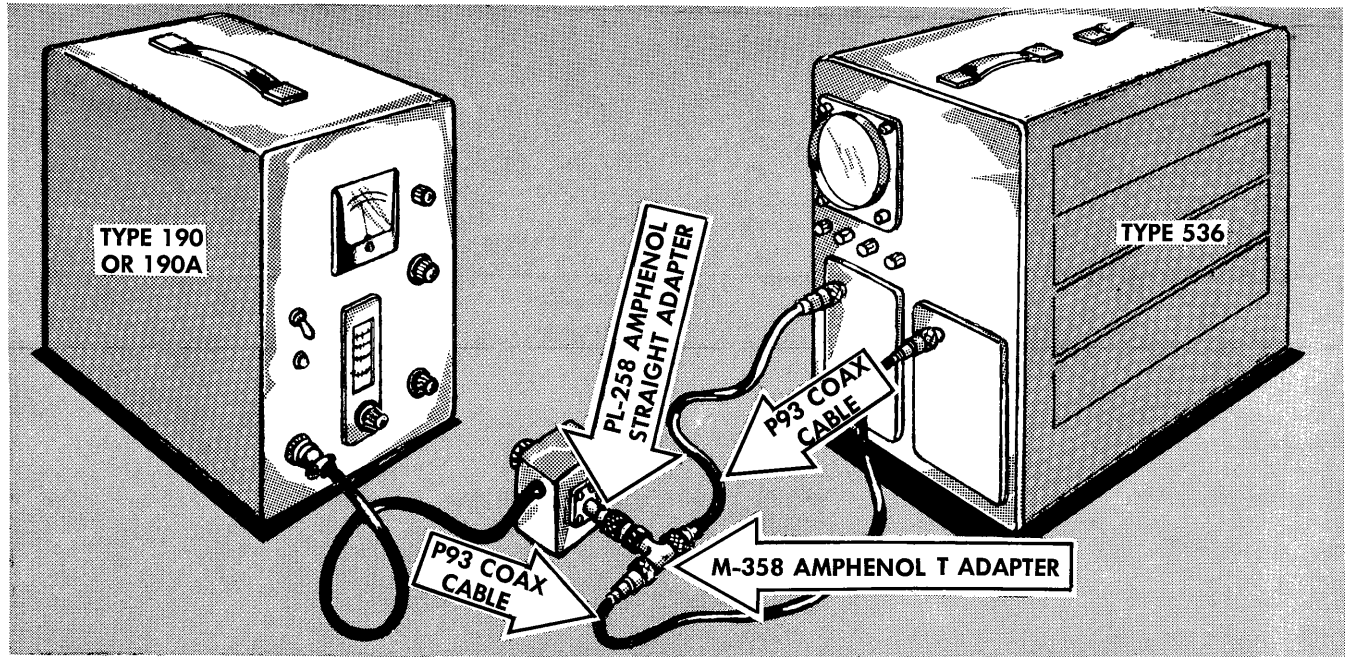

Fig. 6-14. Connecting the Type 190 or 190A Constant-Amplitude Signal Generator to the Type 536.

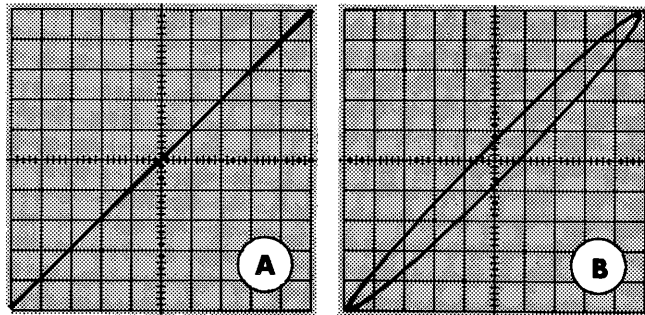
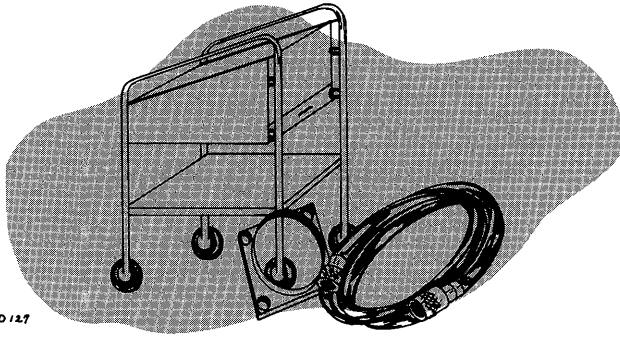

Fig. 6-15. Checking the range of the AMPLIFIER PHASING control.

### 28. Check Amplifier Phase Shift Balance to 30 Mc.

Set the Type 190 or 190A for an output frequency of 20 mc, and adjust the OUTPUT AMPLITUDE control for 5 major divisions of deflection both vertically and horizontally. To be within specifications, there must be a setting of the AMPLIFIER PHASING control, within its range, where the phase difference will be zero.

Increase the frequency of the Signal Generator to 30 mc, and reduce the deflection to 2 major divisions, both vertically and horizontally. To be within specifications, there should be a setting of the AMPLIFIER PHASING control where the phase difference will again be zero.



D 127

# SECTION 7

## ACCESSORIES

### General Information

Your Tektronix instrument has been designed and built to give you maximum performance and versatility. However, for some special applications, there are special accessories available which will increase the versatility of your instru-

ment even more. The accessories which are particularly suited to this instrument are listed in this section.

Accessories should be ordered from your Tektronix Field Engineer or through your nearest Tektronix Field Office by Tektronix part number. Complete, up-to-date price information is also available through your Tektronix Field Engineer or Field Office.

### PROBES

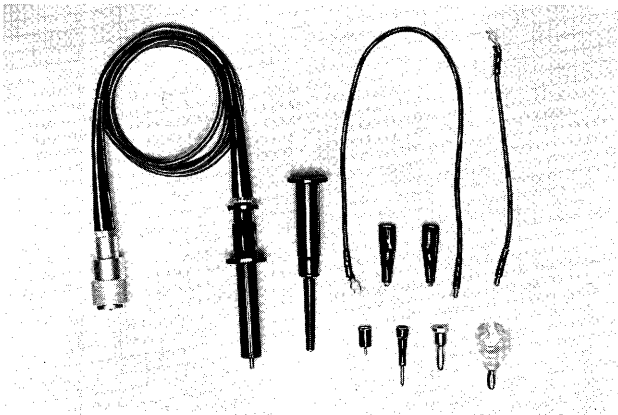

**P6000 Low-Capacitance High-Performance Probe**—The P6000 to P6005 probes preserve the transient response of Tektronix fast-rise, wide-bandpass instruments. These probes are free of overshoot and ringing and have uniform frequency response. They are easy to handle, of rugged construction, and weigh about one ounce. Compensation is accomplished by the rotation of a tubular capacitor; no tools are necessary.

Physical dimensions of the probe body are 7/16 inch in diameter and 3<sup>5</sup>/<sub>8</sub> inches in length without the tip. The standard cable length is 42 inches.

Five interchangeable tips—two straight, one hooked, one pincher, and one banana tip are included with the probe. A 5-inch and a 12-inch ground lead are also included.

### PROBE SPECIFICATIONS

Probe & Connector	Cable Length	Atten. Ratio	Input Impedance			Voltage Rating (Max.)
			Resist. Meg $\Omega$	Capacitance—pf		
				Min. *	Max. **	
P6000-UHF P6003-BNC	42 inch	10X	10	11.5	14.5	600
	6 foot			12.5	15.5	
	9 foot			15.0	18.0	
	12 foot			17.5	20.0	
P6001-UHF P6004-BNC	42 inch	1X	1	68	95	600
	6 foot			94	121	
	9 foot			120	147	
	12 foot			146	173	
P6002-UHF P6005-BNC	42 inch	100X	9.1	2.5	2.8	2000
	6 foot			2.8	3.25	
	9 foot			3.5	4.0	
	12 foot			3.8	4.0	

\* When connected to instruments with 20 pf input capacitance.

\*\* When connected to instruments with input capacitance up to 50 pf.

TEKTRONIX PART NUMBERS

	P6000	P6001	P6002	P6003	P6004	P6005
42 inch	010-020	010-023	010-024	010-027	010-028	010-029
6 foot	010-030	010-032	010-034	010-031	010-047	010-050
9 foot	010-035	010-033	010-043	010-045	010-048	010-051
12 foot	010-041	010-042	010-044	010-046	010-049	010-052

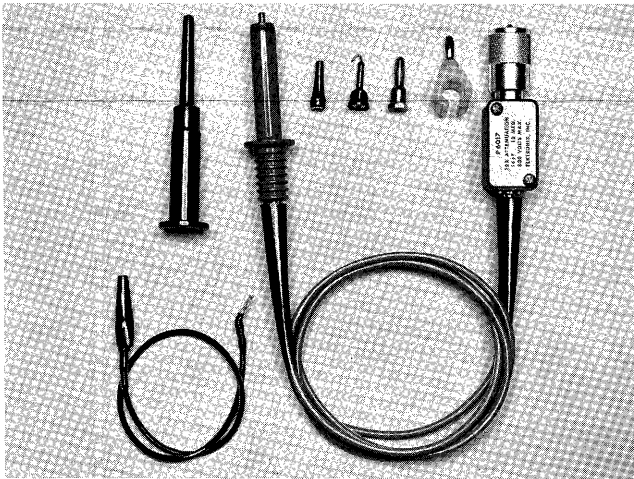

**P6017 Attenuator Probe**—Provides an attenuation of ten times when used with Tektronix oscilloscopes and amplifiers. The P6017 is small and streamlined, and presents an input impedance of 10 megohms paralleled by 14 pf. Probe has a 42" cable with coaxial connector, and is rated at 600 v maximum.

PROBE SPECIFICATIONS

Probe & Connector	Cable Length	Atten. Ratio	Input Impedance			Voltage Rating (Max.)
			Resist. Meg $\Omega$	Capacitance—pf		
				Min. *	Max. **	
P6017-UHF P6022-BNC	42 inch	10X	10	14	14	600
	6 foot			17	17	
	9 foot			20	20	
	12 foot			23	23	
P6027-UHF P6028-BNC	42 inch	1X	1	67	94	600
	6 foot			93	120	
	9 foot			120	147	
	12 foot			146	173	

\* When connected to instruments with 20 pf input capacitance.  
 \*\* When connected to instruments with input capacitance up to 50 pf.

TEKTRONIX PART NUMBERS

	P6017	P6022	P6027	P6028
42 inch	010-038	010-064	010-070	010-074
6 foot	010-056	010-066	010-071	010-075
9 foot	010-057	010-067	010-072	010-076
12 foot	010-058	010-068	010-073	010-077

**P6016 AC Current Probe Systems**—The P6016 AC Current Probe and Type 131 Amplifier constitute a current detecting system for use with any wide-band oscilloscope. This system provides accurate displays for observation and measurement of a-c current waveforms. Current range extends from less than one milliampere to 15 amperes. Use of the current probe and amplifier combination will cause risetime and bandpass figures to deteriorate somewhat from those advertised in the manual for the oscilloscope with which the current probe system is being used.

A second system comprises the P6016 AC current probe with a Passive Termination. Although less versatile than the Type 131 amplifier system, the passive termination arrangement does provide slightly better bandpass.

Long narrow shape and convenient thumb control make the P6016 easy to use. Just place probe slot over conductor and close slide with thumb—no direct electrical connection is required. Wiping action keeps core surfaces clean. Loading introduced is so light that it can almost always be disregarded. For increased sensitivity, loop the conductor around the probe slot two or three times.

ORDER PART NUMBER ..... 010-037

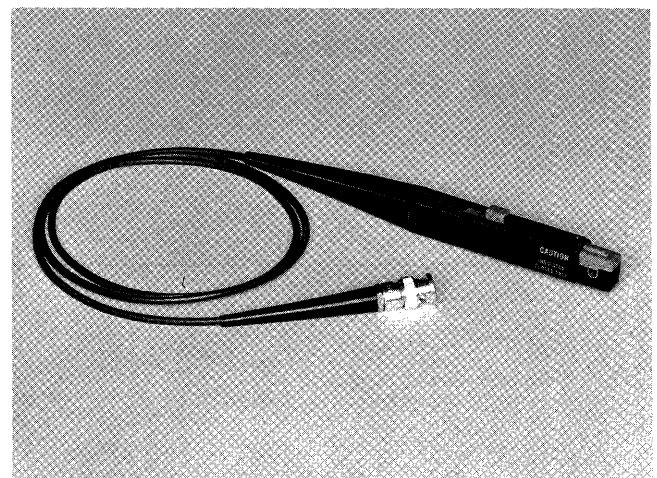

**The Type P6014 High-Voltage Probe**—This new probe provides a means of observing, on an oscilloscope, waveforms of high amplitudes and relatively short duty cycle. DC amplitudes up to 12 kv or short pulses with peak amplitudes up to 25 kv can be measured without damage to the probe.

Attenuation Ratio—1000 to 1.

Frequency Response—dc to over 30 mc.

Input Impedance—10 megohms and 3 pf.

Pulse Rating—10% or less duty cycle with maximum pulse duration of 0.1 sec.



A compensating box on the oscilloscope end enables the P6014 probe to be properly compensated to any oscilloscope having an input capacitance of 20 to 47 pf. The probe introduces no ringing or overshoot.

Probe body length is 12 inches, coaxial cable length is 10 feet.

The probe includes 2 banana-plug tips, an alligator-clip assembly, and an attached 7½ inch ground lead.

ORDER PART NUMBER ..... 010-025

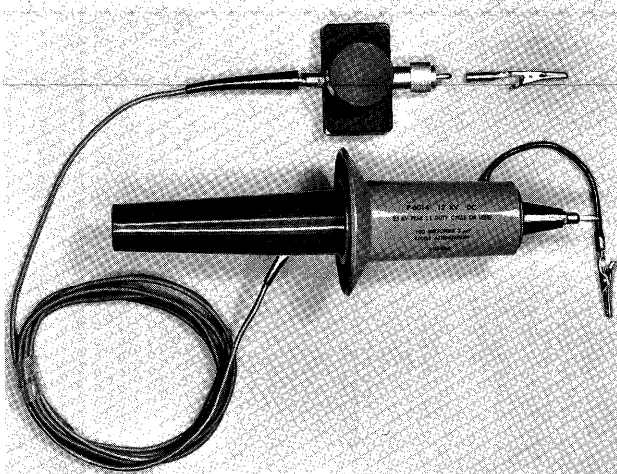

**P170CF Cathode-Follower Probe.** The cathode-follower tube is a 5718 triode whose cathode load is the 170-ohm termination of the preamplifier grid line in the Type 517. Plate and heater voltages for this tube are provided at a four-terminal socket on the panel of the oscilloscope. The signal is attenuated by 2 times when using the P170CF. The input impedance of the probe will depend on the attenuator head being used, also since transit time in the cathode-follower tube is involved, it will decrease appreciably at the higher frequencies. When the probe is used without an attenuator head, the input looks like 12 megohms shunted by 5 pf. The probe cable is 42" long. Probe complete with 3 attenuator heads

ORDER PART NUMBER ..... 010-101

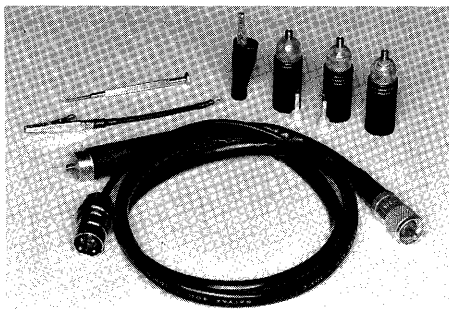

### Replacement Attenuator Heads

PAX-I Attenuator Head for P170CF, attenuation can be varied between 4 times and 40 times.

ORDER PART NUMBER ..... 010-301

PAX-II Attenuator Head for P170CF, attenuation can be varied between 20 times and 200 times.

ORDER PART NUMBER ..... 010-302

PAX-III Attenuator Head for P170CF, attenuation can be varied between 200 times and 2000 times.

ORDER PART NUMBER ..... 010-303

**P500CF Cathode-Follower Probe**—Presents low capacitance with minimum attenuation. Input impedance is 40 megohms paralleled by 4 pf, gain 0.8 to 0.85. Input to probe is ac-coupled, limiting its low-frequency response to

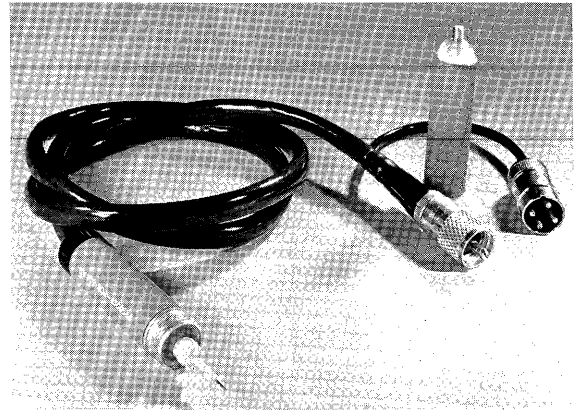

5 cycles. Amplitude distortion is less than 3% on unidirectional signals up to 5 volts. 10x attenuator head is included with probe, and should be used on signals exceeding a few volts to minimize amplitude distortion. With the attenuator head attached, the probe input impedance is approximately 10 megohms paralleled by 2 pf. Probe output level is 11 v positive, making it necessary to use the ac-coupled position of the oscilloscope AC-DC switch. Probe cable is 42" long.

ORDER PART NUMBER ..... 010-105

### TYPE 128 PROBE POWER SUPPLY

**Type 128 Probe Power Supply**—For P500CF and P170CF cathode-follower probes. The Type 128 supplies the neces-



sary plate and filament voltages for one or two probes, making it possible to use the cathode-follower probes with oscilloscopes not equipped with a probe-power outlet.

DC Output Voltages:

+120 v regulated, at 25 ma

Two +6.3 v unregulated, at 150 ma



**Accessories — Type 536**

The two cathode-follower probe connections have separate +6.3 v dc voltage supplies.

When a P170CF probe is to be used with an instrument other than the Tektronix Type 517, a 170-ohm terminating resistor is required. The Tektronix 011-016, 170 ohms, 0.5 w Terminating Resistor is recommended for this purpose.

Ripple on the 120 v supply is not more than 5 mv peak-to-peak, and not more than 75 mv peak-to-peak on the 6.3 v supplies.

Power Requirements—105 to 125 v or 210 to 250 v, 50 to 60 cycles, 25 watts using two P500CF probes.

Dimensions—4<sup>3</sup>/<sub>4</sub>" wide, 7<sup>3</sup>/<sub>4</sub>" high, 9" overall depth.

Weight—6 lbs.

Includes: 1—3-conductor power cord (161-010)

**Probe Power-Cable Extension**—A 24" 3-conductor power-cable extension for Tektronix cathode-follower probes. Permits wider separation of the probe power source from the instrument signal input.

ORDER PART NUMBER ..... 012-030

**CALIBRATION ACCESSORIES**

The Type TU-2 Test-Load Plug-In Unit is a convenient special-purpose test tool for the maintenance of Tektronix Type 530, 530A, 540, 540A-Series Oscilloscopes. The unit is used to check power-supply regulation under high load and low load demands of all A to Z plug-in units. It can also



be used to check vertical amplifier balance, vertical amplifier gain, and dual-trace function of the oscilloscope. It eliminates the need to keep plug-in preamplifiers in the maintenance area to make these checks.

ORDER PART NUMBER ..... 015-012

**ATTENUATORS and TERMINATIONS**

PART NO.	DESCRIPTION
011-001	52-ohm termination, 1.5 w
011-002	52-ohm 'L' attenuator, 5 to 1 voltage ratio, 1.5 w
011-003	52-ohm 'L' attenuator, 10 to 1 voltage ratio, 1.5 w
011-004	Minimum-loss termination, 52 ohms to 75 ohms
011-005	Minimum-loss termination, 52 ohms to 170 ohms
011-027	52-ohm 'T' attenuator, 5 to 1 voltage ratio, 1.5 w
011-006	52-ohm 'T' attenuator, 10 to 1 voltage ratio, 1.5 w

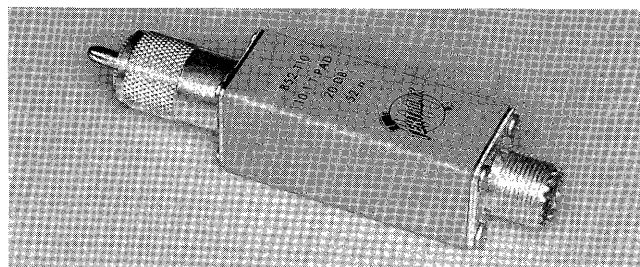

- 011-026 52-ohm to 170 ohm termination, 10 to 1 voltage ratio, 1.5 w
- 011-007 75-ohm termination, 1.5 w
- 011-008 75-ohm 'L' attenuator, 5 to 1 voltage ratio, 1.5 w
- 011-009 75-ohm 'L' attenuator, 10 to 1 voltage ratio, 1.5 w
- 011-010 75-ohm 'T' attenuator, 10 to 1 voltage ratio, 1.5 w
- 011-011 93-ohm termination, 1.5 w
- 011-012 93-ohm 'L' attenuator, 5 to 1 voltage ratio, 1.5 w
- 011-013 93-ohm 'L' attenuator, 10 to 1 voltage ratio, 1.5 w
- 011-014 Minimum-loss termination, 93 ohms to 52 ohms, 1.5 w
- 011-015 93-ohm 'T' attenuator, 10 to 1 voltage ratio, 1.5 w
- 011-016 170-ohm termination, 0.5 w

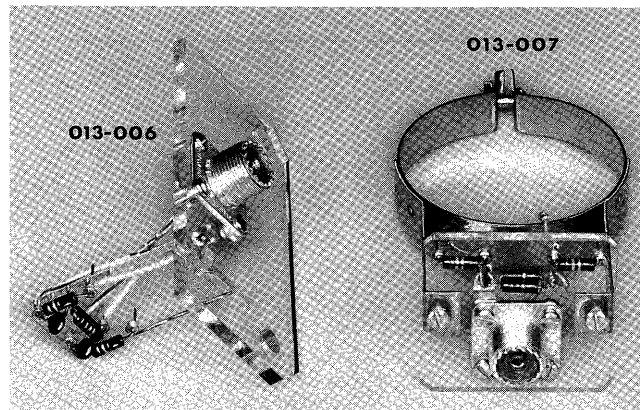

**Deflection Plate Connectors**—For Type 530, 540, 530A, and 540A-Series Oscilloscopes. A convenient means of making a connection directly to the cathode-ray tube vertical deflection plates to realize the maximum frequency response of the crt. Designed for use with high-frequency, fast-rise pulses or transient signals. Under these conditions

the function of the vertical position control of the oscilloscope is retained. The connectors are designed for use with 52-ohm cables. The connectors are not recommended for use with frequencies below 8 kc or pulses with correspondingly slow risetimes.

- For instruments with serial number below 5001,  
ORDER PART NUMBER ..... 013-006
- For instruments with serial numbers 5001 and above,  
ORDER PART NUMBER ..... 013-007

**INTERCONNECTING CABLES**

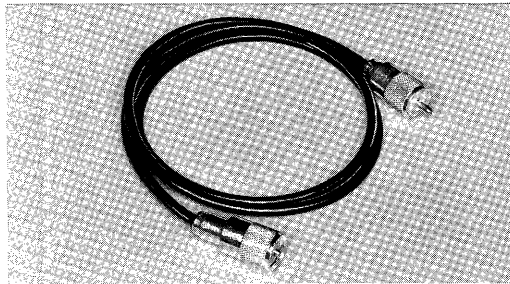

- 52-ohms nominal impedance, 42 inches long.  
ORDER PART NUMBER ..... 012-001
- 75-ohms nominal impedance, 42 inches long.  
ORDER PART NUMBER ..... 012-002
- 93-ohms nominal impedance, 42 inches long.  
ORDER PART NUMBER ..... 012-003
- 93-ohms, 42 inches long, terminated with variable attenuator.  
ORDER PART NUMBER ..... 012-004
- 93-ohms, 42 inches long, terminated with 1/2 watt 93 ohm resistor.  
ORDER PART NUMBER ..... 012-005
- 170-ohms nominal impedance, 42 inches long.  
ORDER PART NUMBER ..... 012-006

**ADAPTERS**

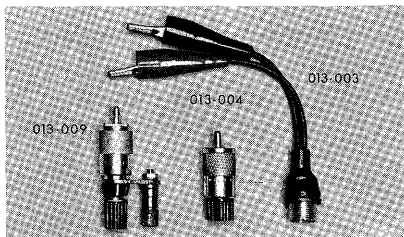

- 013-003 Adapter, clip lead
- 013-004 Adapter, binding post
- 013-009 Binding Post Adapter with ground terminal, 3/4" spacing

**STANDARDIZERS**

- 47 pf Input Capacitance Standardizer**—For use with Type A to Z Plug-In Preampifiers having an input capacitance of 47 pf. With this accessory the input capacitance of each preampifier can be standardized to 47 pf.  
ORDER PART NUMBER ..... 011-021



- 20 pf Input Capacitance Standardizer**—Similar to 011-021 for use with the Types CA, K and L Plug-In Preampifiers having 20 pf input capacitance.  
ORDER PART NUMBER ..... 011-022

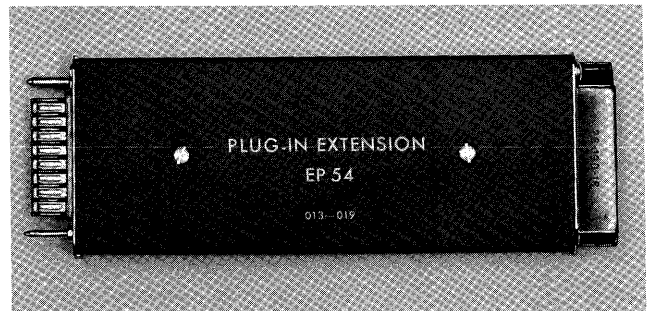

- Plug-in Extension**—Six inches long and allows the plug-in preampifier unit for the Type 530, 530A, 540, 540A-Series Oscilloscopes to be operated partially out of its housing.  
ORDER PART NUMBER ..... 013-019

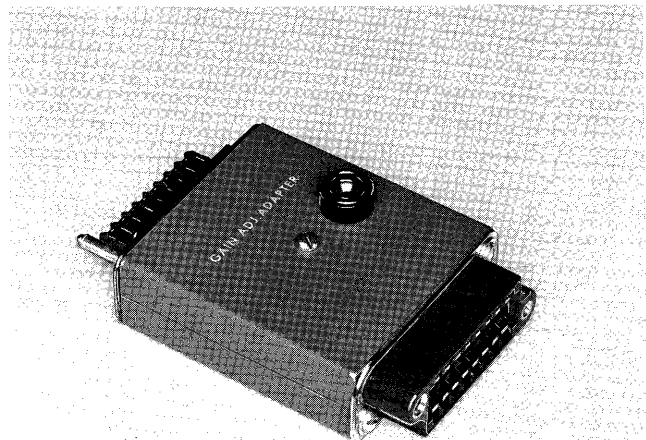

- Gain Adjust Adapter**—Permits an external calibrating signal to bypass the plug-in preampifier, for calibrating the sensitivity of the main amplifier of Type 530, 530A, 540, 540A-Series Oscilloscopes.  
ORDER PART NUMBER ..... 013-005

## MISCELLANEOUS ACCESSORIES

### SCOPEMOBILES

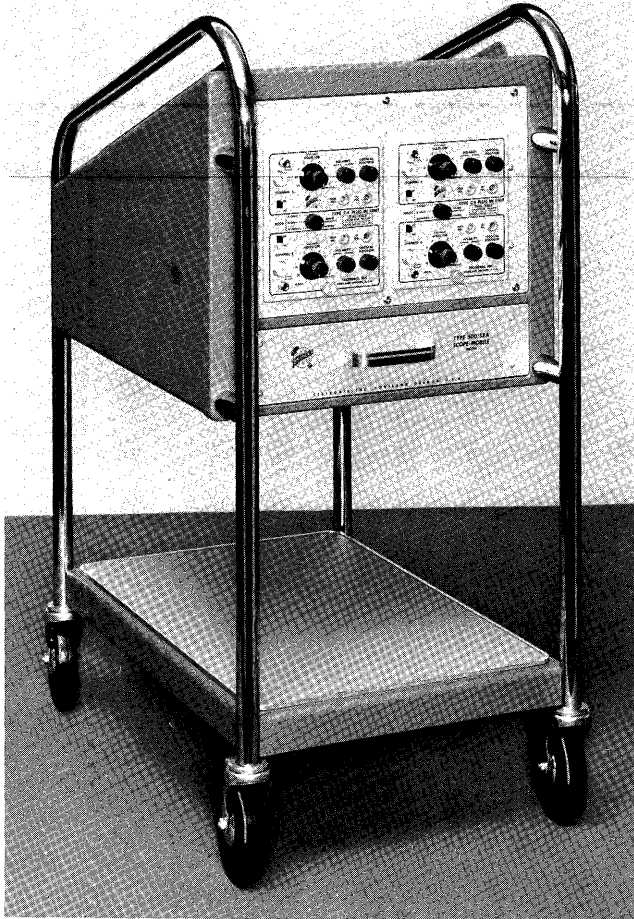

**TYPE 500/53A**

The Tektronix Type 500/53A Scope-Mobile is a sturdy, mobile support for Tektronix 5" Oscilloscopes. Convenient observation of the crt face is achieved by a 20-degree backward tilt of the top surface. The front panel has two supporting cradles to accommodate Tektronix Preamplifier Plug-In units. A drawer, felt-lined and operating on roller bearings, provides handy storage for probes, cables, manuals etc. An open shelf, 14<sup>5</sup>/<sub>8</sub>" wide, 12<sup>1</sup>/<sub>2</sub>" high, and 23<sup>5</sup>/<sub>8</sub>" deep, topped with tough linoleum, is located at the bottom. Power input and three convenience outlets are mounted at the rear. Total weight is 35 pounds. Dimensions are 17<sup>3</sup>/<sub>4</sub>" wide, 38" high and 27" deep. Space requirements for height and depth will vary with the type of instrument being used.

Includes: 1—3-conductor power cord (161-014)

**Scope-Mobile Panel**—for Type 500A Scope-Mobiles. Converts the Type 500A to a Type 500/53A by replacing the standard blank panel.

ORDER PART NUMBER ..... 014-005



**TYPE 500A**

The Tektronix Type 500A Scope-Mobile is identical to the Type 500/53A, except for the front panel. Auxiliary equipment can be mounted behind the blank front panel in a space 13<sup>3</sup>/<sub>4</sub>" wide, and 8<sup>1</sup>/<sub>2</sub>" high for the first 5<sup>1</sup>/<sub>2</sub>" of depth and tapering in height from this point, on a 20 degree angle

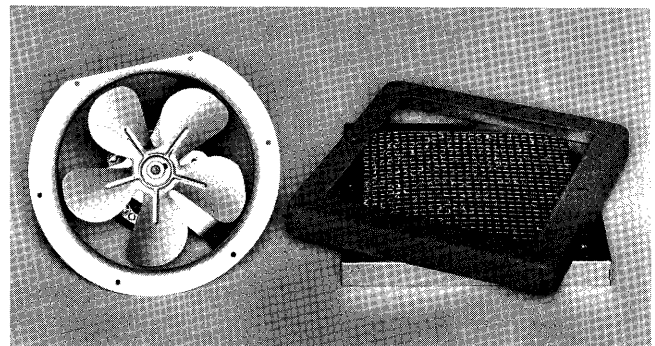

Scopemobile fan kit



to a minimum height of 2½" at a depth of 19½". It will usually be necessary to provide forced-air ventilation for the equipment compartment. A fan kit, 040-161, is recommended for this purpose.

Includes: 1—3-conductor power cord (161-014)

**Scope-Mobile Panel**—For Type 500 Scope-Mobiles only. Converts the earlier Type 500 model to a Type 500/53 by replacing the standard blank panel.

ORDER PART NUMBER ..... 014-004

**Scope-Mobile Fan Kit**—for forced-air ventilation of the equipment compartment of the Type 500A Scope-Mobile. Provides an air flow of 84 cfm with the Scope-Mobile drawer in place. With the drawer removed and a panel covering the drawer opening, the air flow is increased to 94 cfm. Contains motor, 5" blade, filter and mounting hardware.

ORDER PART NUMBER ..... 040-161

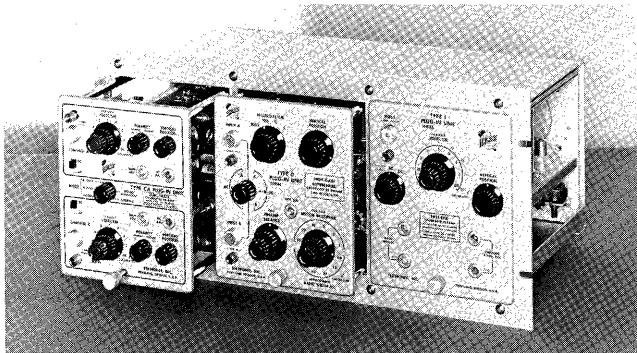

**Plug-In Preamplifier Storage Cabinet**—Mounts in standard rack, holds three Tektronix Plug-In Preamplifiers. Dimensions: 19" wide, 8¾" high, 9¾" deep.

ORDER PART NUMBER ..... 437-031



**Bezel**—For mounting camera on Tektronix 5" oscilloscopes. Dimensions—5⅞" square; ring ⅞" deep, diameter 5⅝" outside, 5⅛" inside. Die-cast construction, wrinkle finish, felt lined.

ORDER PART NUMBER ..... 014-001

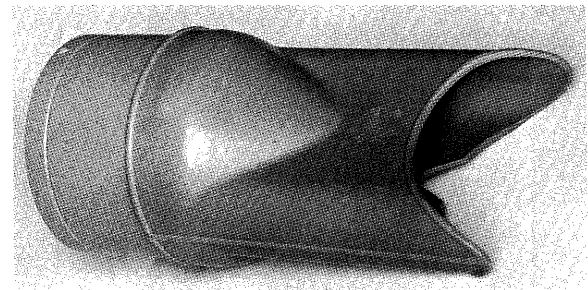

**Viewing Hood**—For Tektronix 5" Oscilloscopes. Includes molded rubber eye-piece and aluminum light shield.

ORDER PART NUMBER ..... 016-001

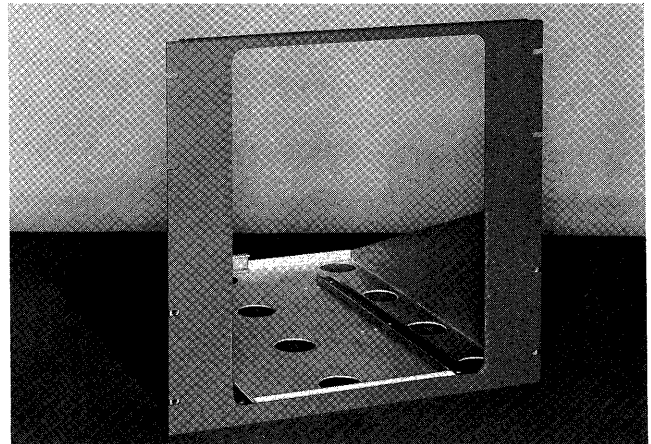

**Cradle-Mount**—For rack mounting cabinet-type oscilloscopes. Each cradle-mount consists of a cradle (or "shelf") to support the instrument in any standard 19" relay rack, and a mask to fit over the regular instrument panel. Tek blue wrinkle finish.

For Type 530-series, Type 540-series with serial numbers above 5000, Type 530A-series, Type 540A-series all serial numbers.

ORDER PART NUMBER ..... 040-182

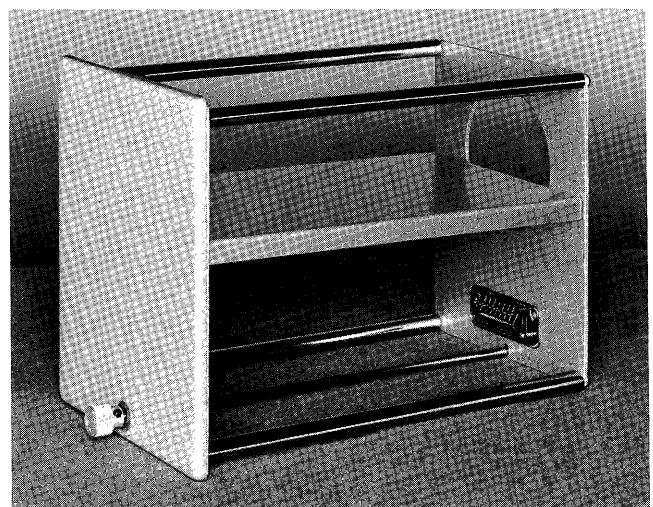

**Blank Plug-In Skeleton**

ORDER PART NUMBER ..... 040-065





## **HOW TO ORDER PARTS**

Replacement parts are available through your local Tektronix Field Office.

Improvements in Tektronix instruments are incorporated as soon as available. Therefore, when ordering a replacement part it is important to supply the part number including any suffix, instrument type, serial number, plus a modification number where applicable.

If the part you have ordered has been improved or replaced, your local Field Office will contact you if there is a change in part number.



# PARTS LIST

Values are fixed unless marked Variable.

## Bulbs

Ckt. No.	S/N Range	Description	Tektronix Part Number
B279		Neon, NE-2	150-002
B285		Neon, NE-2	150-002
B379		Neon, NE-2	150-002
B385		Neon, NE-2	150-002
B601		Incandescent, #47	150-001
B602		Incandescent, #47	150-001
B603		Incandescent, #47	150-001
B681		Neon, NE-2	150-002
B682		Neon, NE-2	150-002

## Capacitors

Tolerance  $\pm 20\%$  unless otherwise indicated.

C202		.01 $\mu f$	Cer.		150 v		283-003
C214		.001 $\mu f$	Cer.		500 v		283-000
C252	101-614X	2.7-10.8 $\mu\mu f$	Air	Var.			281-033
C253		2.7-10.8 $\mu\mu f$	Air	Var.			281-033
C254	101-614 615-up	.7-3 $\mu\mu f$	Tub.	Var.			281-027
		.5-5 $\mu\mu f$	Tub.	Var.			281-001
C262A	101-226	10 $\mu f$	EMC		450 v		290-067
C262B	101-226	10 $\mu f$					
C262A	227-up	10 $\mu f$	EMC		450 v		290-033
C262B	227-up	10 $\mu f$					
C276		.01 $\mu f$	PTM		400 v		285-510
C290		4.7 $\mu\mu f$	Cer.		500 v	$\pm 1 \mu\mu f$	281-501
C292		.5-5 $\mu\mu f$	Tub.	Var.	500 v		281-001
C298		.01 $\mu f$	Cer.		150 v		283-003
C302		.01 $\mu f$	Cer.		150 v		283-003
C314		.001 $\mu f$	Cer.		500 v		283-000
C352		2.7-10.8 $\mu\mu f$	Air	Var.			281-033
C362A	101-226	10 $\mu f$	EMC		450 v		290-067
C362B	101-226	10 $\mu f$					
C362A	227-up	10 $\mu f$	EMC		450 v		290-033
C362B	227-up	10 $\mu f$					
C366	101-614X	.7-3 $\mu\mu f$	Tub.	Var.			281-027
C376		.01 $\mu f$	PTM		400 v		285-510
C390		4.7 $\mu\mu f$	Cer.		500 v	$\pm 1 \mu\mu f$	281-501
C392		.5-5 $\mu\mu f$	Tub.	Var.	500 v		281-001
C398		.01 $\mu f$	Cer.		150 v		283-003
C554		330 $\mu\mu f$	Mica		500 v	10%	283-518
C558		330 $\mu\mu f$	Mica		500 v	10%	283-518
C576		27 $\mu\mu f$	Cer.		500 v	$\pm 2.7 \mu\mu f$	281-512
C590		.001 $\mu f$	Cer.		500 v		283-000
C613		.01 $\mu f$	PTM		600 v		285-511

**Capacitors (continued)**

					Tektronix Part Number
C618A,B,C		3 x 10 $\mu$ f	EMC	450 v	290-033
C622		125 $\mu$ f	EMC	350 v	290-044
C624		125 $\mu$ f	EMC	450 v	290-045
C625		150 $\mu$ f	EMC	250 v	290-048
C626		150 $\mu$ f	EMC	250 v	290-048
C628		125 $\mu$ f	EMC	350 v	290-044
C642		.01 $\mu$ f	PTM	600 v	285-511
C647		.01 $\mu$ f	PTM	600 v	285-511
C662		.01 $\mu$ f	PTM	600 v	285-511
C682		.001 $\mu$ f	PTM	600 v	285-501
C688		.01 $\mu$ f	PTM	600 v	285-511
C695		.01 $\mu$ f	PTM	600 v	285-511
C698		2 x 40 $\mu$ f	EMC	250 v	290-040
C710		2 x 15 $\mu$ f	EMC	350 v	290-056
C712A,B,C		3 x 10 $\mu$ f	EMC	450 v	290-033
C718	X1203-up	.02 $\mu$ f	Cer.	600 v	283-006
C720		2 x 15 $\mu$ f	EMC	350 v	290-056
C722A,B,C		3 x 10 $\mu$ f	EMC	350 v	290-033
C728	X1203-up	.02 $\mu$ f	Cer.	600 v	283-006
C803		.001 $\mu$ f	PTM	600 v	285-501
C805		.01 $\mu$ f	PTM	600 v	285-511
C806		.001 $\mu$ f	PTM	600 v	285-501
C807A,B		3 x 10 $\mu$ f	EMC	450 v	290-033
C812		.01 $\mu$ f	Cer.	500 v	283-002
C814	101-1339	.0068 $\mu$ f	PTM	3000 v	285-508
	1340-up	.01 $\mu$ f	Cer.	2000 v	283-011
C820	101-1339	.0068 $\mu$ f	PTM	3000 v	285-508
	1340-up	.01 $\mu$ f	Cer.	2000 v	283-011
C821		.005 $\mu$ f	Cer.	4000 v	Use 283-034
C828	X1740-up	.1 $\mu$ f	Discap	100 v	283-012
C830	101-1339	.0068 $\mu$ f	PTM	3000 v	285-508
	1340-up	.01 $\mu$ f	Cer.	2000 v	283-011
C832	101-1339	.0068 $\mu$ f	PTM	3000 v	285-508
	1340-up	.01 $\mu$ f	Cer.	2000 v	283-011
C835	101-1189	.015 $\mu$ f	PTM	3000 v	285-513
	1190-up	.01 $\mu$ f	Cer.	2000 v	283-011
C848		1 $\mu$ f	PTM	600 v	285-528
C855	101-1189	.015 $\mu$ f	PTM	3000 v	285-513
	1190-up	.01 $\mu$ f	Cer.	2000 v	283-011
C857	101-1189	.015 $\mu$ f	PTM	3000 v	285-513
	1190-up	.01 $\mu$ f	Cer.	2000 v	283-011

**Diodes \***

D602A,B	X1203-up	Silicon Diode		152-047
D612A,B	X1203-up	Silicon Diode		152-047
D622A,B,C,D	X1203-up	Silicon Diode		152-047
D632A,B,C,D	X1203-up	Silicon Diode		152-047

**Fuses**

F600	101-1202	6 amp 3 AG Fast-Blo (117 v operation)		159-013
		3 amp 3 AG Slo-Blo (234 v operation)		159-005
	1203-up	6.25 3 AG Slo-Blo (117 v operation) 60 cycle & 50 cycle		159-011
		3.2 amp 3 AG Slo-Blo (234 v operation) 60 cycle		159-026
		3 amp 3AG Slo-Blo (234 v operation) 50 cycle		159-005

\* Even though the diodes may be different in physical size, they are direct electrical replacements for the diodes in your instrument.

### Inductors

				Tektronix Part Number
L204		9-19 $\mu$ h	Var.	*114-067
L205		1.8 $\mu$ h		*108-105
L223		3.6-8.3 $\mu$ h	Var.	*114-055
L224		9-19 $\mu$ h	Var.	*114-067
L225		1.8 $\mu$ h		*108-105
L242	101-614	.45 $\mu$ h		*108-062
	615-up	.18 $\mu$ h		*108-009
L243	101-614	.45 $\mu$ h		*108-062
	615-up	.75 $\mu$ h		*108-072
L244	101-614	.45 $\mu$ h		*108-062
	615-up	.18 $\mu$ h		*108-009
L245	101-614	.45 $\mu$ h		*108-062
	615-up	.75 $\mu$ h		*108-072
L249	X615-up	3.2 $\mu$ h		*108-088
L250		7-11.5 $\mu$ h	Var.	*114-068
L251		.75 $\mu$ h		*108-072
L254		.75 $\mu$ h		*108-072
L255	X615-up	3.2 $\mu$ h		*108-088
L256		7-11.5 $\mu$ h	Var.	*114-068
L304		9-19 $\mu$ h	Var.	*114-067
L305		1.8 $\mu$ h		*108-105
L323		3.6-8.3 $\mu$ h	Var.	*114-055
L324		9-19 $\mu$ h	Var.	*114-067
L325		1.8 $\mu$ h		*108-105
L343		.75 $\mu$ h		*108-072
L345		.75 $\mu$ h		*108-072
L349	X615-up	3.2 $\mu$ h		*108-088
L350		7-11.5 $\mu$ h	Var.	*114-068
L351		.75 $\mu$ h		*108-072
L354		.75 $\mu$ h		*108-072
L355	X615-up	3.2 $\mu$ h		*108-088
L356		7-11.5 $\mu$ h	Var.	*114-068

### Rectifiers †

SR620	101-1202X	4-250 ma plates/leg	}	*106-041
SR624	101-1202X	4-250 ma plates/leg		
SR626	101-1202X	5-500 ma plates /leg	}	*106-013
SR628	101-1202X	5-250 ma plates/leg		

Note: A kit is available to convert from Selenium Rectifiers to Silicon Diodes, Order Mod. Kit 040-215.

† S/N 1203 up see V602, V612, V622 and V632.

### Resistors

Resistors are fixed, composition,  $\pm 10\%$  unless otherwise indicated.

R200	10 meg	$\frac{1}{2}$ w			302-106
R201	47 $\Omega$	$\frac{1}{2}$ w			302-470
R202	100 $\Omega$	$\frac{1}{2}$ w			302-101
R203	3 k	5 w	WW	5%	308-062
R204	1.6 k	$\frac{1}{2}$ w	Prec.	1%	310-531

## Resistors (continued)

							Tektronix Part Number
R205		15 k	1 w				304-153
R207	101-227	6 k	5 w		WW	5%	Use 308-111
	228-up	6 k	8 w		WW	5%	308-111
R208		3.3 k	2 w			5%	305-332
R209		3.3 k	2 w			5%	305-332
R212		100 k	1/2 w				302-104
R213		500 Ω	2 w	Var.		Gain Adjust	311-005
R214		100 k	1/2 w				302-104
R220		10 meg	1/2 w				302-106
R221		47 Ω	1/2 w				302-470
R223		56 Ω	1/2 w				302-560
R224		1.6 k	1/2 w		Prec.	1%	310-531
R226		150 k	1/10 w				307-014
R227		47 Ω	1/2 w				302-470
R228	101-306	4.7 k	2 w				306-472
	307-up	5.6 k	2 w				306-562
R231	101-315	18 k	2 w				Use 305-183
	316-up	18 k	2 w			5%	305-183
R234	101-315	18 k	2 w				Use 305-183
	316-up	18 k	2 w			5%	305-183
R236		150 k	1/10 w				307-014
R237		47 Ω	1/2 w				302-470
R240		47 Ω	1/2 w				302-470
R241		3 k	5 w		WW	5%	308-062
R243	101-315	5.6 k	2 w				Use 305-562
	316-up	5.6 k	2 w			5%	305-562
R244		3 k	5 w		WW	5%	308-062
R245	101-315	5.6 k	2 w				Use 305-562
	316-up	5.6 k	2 w			5%	305-562
R247		47 Ω	1/2 w				302-470
R249	101-614X	167 Ω	5 w		WW	5%	308-045
R250		1.25 k	10 w		Mica Plate	1%	*310-530
R251	101-614	22 Ω	1/2 w				302-220
	615-up	10 Ω	1/2 w				302-100
R252	X615-up	10 Ω	1/2 w				302-100
R253		333 Ω	10 w		WW	5%	308-049
R254	101-614	22 Ω	1/2 w				302-220
	615-up	10 Ω	1/2 w				302-100
R256		1.25 k	10 w		Mica Plate	1%	*310-530
R257	X615-up	10 Ω	1/2 w				302-100
R259	101-181	1 k	2 w				306-102
	182-614	2 k		Var.		Screen Volts Adj.	311-008
	615-up	2 k	5 w		WW	5%	308-091
R262		82 k	1/2 w				302-823
R263		1 meg	2 w	Var.		Hor. DC Shift Comp.	311-039
R264		82 k	1/2 w				302-823
R272		1 meg	1/2 w				302-105
R273		1 meg	1/2 w				302-105
R274		1.2 meg	1/2 w				302-125
R275		2 meg	1/10 w	Var.		Beam-Pos.-Ind. Centering	311-082
R276		4.7 meg	1/2 w				302-475
R279		68 k	1/2 w				302-683
R281		15 k	1/2 w				302-153

## Resistors (continued)

							Tektronix Part Number
R282		27 k	1/2 w				302-273
R285		47 k	1/2 w				302-473
R286		270 k	1/2 w				302-274
R290	101-1979	680 k	1/2 w				302-684
	1980-up	680 k	1/2 w			5%	301-684
R294		39 k	1 w				304-393
R295		20 k	2 w	Var.		Hor. Sig. Out DC Level Adj.	311-018
R296	101-1979	330 k	1/2 w				302-334
	1980-up	330 k	1/2 w			5%	301-334
R297		100 Ω	1/2 w				302-101
R298		100 Ω	1/2 w				302-101
R299		22 k	2 w				306-223
R300		10 meg	1/2 w				302-106
R301		47 Ω	1/2 w				302-470
R302		100 Ω	1/2 w				302-101
R303		3 k	5 w			WW	308-062
R304		1.6 k	1/2 w			Mica Plate	*310-531
R305		15 k	1 w				304-153
R307	101-227	6 k	5 w			WW	Use 308-111
	228-up	6 k	8 w			WW	308-111
R308		3.3 k	2 w				305-332
R309		3.3 k	2 w				305-332
R312		100 k	1/2 w				302-104
R313		500 Ω	2 w	Var.		Vert. Gain Adj.	311-005
R314		100 k	1/2 w				302-104
R320		10 meg	1/2 w				302-106
R321		47 Ω	1/2 w				302-470
R323		56 Ω	1/2 w				302-560
R324		1.6 k	1/2 w			Mica Plate	*310-531
R326		150 k	1/10 w				307-014
R327		47 Ω	1/2 w				302-470
R328		4.7 k	2 w				306-472
R331	101-315	18 k	2 w				Use 305-183
	316-up	18 k	2 w				305-183
R334	101-315	18 k	2 w				Use 305-183
	316-up	18 k	2 w				305-183
R336		150 k	1/10 w				307-014
R337		47 Ω	1/2 w				302-470
R340		47 Ω	1/2 w				302-470
R341		3.3 k	2 w				306-332
R343	101-315	8.2 k	2 w				Use 305-822
	316-up	8.2 k	2 w				305-822
R344		3.3 k	2 w				306-332
R345	101-315	8.2 k	2 w				Use 305-822
	316-up	8.2 k	2 w				305-822
R347		47 Ω	1/2 w				302-470
R349	101-614X	167 Ω	5 w			WW	308-045
R350		1.25 k	10 w			Mica Plate	*310-530
R351	101-614	100 Ω	1/2 w				302-101
	615-up	10 Ω	1/2 w				302-100
R352	X615-up	10 Ω	1/2 w				302-100
R353		333 Ω	10 w			WW	308-049

Resistors (continued)

									Tektronix Part Number
R354	101-614	100 Ω	1/2 w						302-101
	615-up	10 Ω	1/2 w						302-100
R356		1.25 k	10 w		Mica Plate	1%			*310-530
R357	X615-up	10 Ω	1/2 w						302-100
R359	101-454	2.25 k	2 w	Var.				Use	311-008
	455-614	2 k	2 w	Var.		Screen Volts Adj.			311-008
	615-up	2 k	5 w		WW	5%			308-091
R362		82 k	1/2 w						302-823
R363		1 meg	2 w	Var.		Vert. DC Shift Adj.			311-039
R364		82 k	1/2 w						302-823
R372		1 meg	1/2 w						302-105
R373		1 meg	1/2 w						302-105
R374		1.2 meg	1/2 w						302-125
R375		2 meg	1/10 w	Var.		Beam-Pos.-Ind. Centering			311-082
R376		4.7 meg	1/2 w						302-475
R379		68 k	1/2 w						302-683
R381		15 k	1/2 w						302-153
R382		27 k	1/2 w						302-273
R385		47 k	1/2 w						302-473
R386		270 k	1/2 w						302-274
R390	101-1979	680 k	1/2 w						302-684
	1980-up	680 k	1/2 w			5%			301-684
R394		39 k	1 w						304-393
R395		20 k	2 w	Var.		Vert. Sig. Out DC Level Adj.			311-018
R396	101-1979	330 k	1/2 w						302-334
	1980-up	330 k	1/2 w			5%			301-334
R397		100 Ω	1/2 w						302-101
R398		100 Ω	1/2 w						302-101
R399		22 k	2 w						306-223
R550		150 k	1/2 w						302-154
R552		1 k	1/2 w						302-102
R554		3.3 meg	1/2 w						302-335
R556		2.7 meg	1/2 w						302-275
R558		1 k	1/2 w						302-102
R562		68 k	1/2 w						302-683
R564		33 k	1 w						304-333
R566		10 k	2 w	Var.		Cal. Adj.			311-016
R567		100 k	1/2 w						302-104
R570		1.5 meg	1/2 w						302-155
R572		100 Ω	1/2 w						302-101
R577		9.5 k	1/2 w			Prec.	1%		309-121
R578		6.375 k	1/2 w			Prec.	1%		309-119
R579		2.1 k	1/2 w			Prec.	1%		309-117
R580		1.025 k	1/2 w			Prec.	1%		309-116
R581		610 Ω	1/2 w			Prec.	1%		309-113
R582		200 Ω	1/2 w			Prec.	1%		309-073
R583		100 Ω	1/2 w			Prec.	1%		309-112
R584		60 Ω	1/2 w			Prec.	1%		309-067
R585		40 Ω	1/2 w			Prec.	1%		309-066

## Resistors (continued)

							Tektronix Part Number
R589		100 k	1/2 w		Prec.	1%	309-045
R590		100 Ω	1/2 w		Prec.	1%	309-112
R594		100 Ω	1/2 w				302-101
R595		.25 Ω	1 w		WW		308-090
R601		50 Ω	2 w	Var.	WW	SCALE ILLUM.	311-055
R603	101-705 706-up	560 k	1/2 w				Use 302-474
		470 k	1/2 w				302-474
R604		82 k	1/2 w				302-823
R607		1.5 meg	1/2 w				302-155
R609		1 k	1/2 w				302-102
R610		1 k	1/2 w				302-102
R613		2.2 meg	1/2 w				302-225
R614	101-1579 1580-up	236 k	1 w		WW	1%	308-083
		237 k	1 w		Prec.		310-124
R615	101-1579 1580-up	100 k	1/2 w		WW	1%	Use 309-334
		100 k	1/2 w		Prec.		309-334
R616		200 Ω	20 w		WW	5%	308-028
R617		200 Ω	20 w		WW	5%	308-028
R618		200 Ω	20 w		WW	5%	308-028
R620		10 Ω	2 w				306-100
R621		10 Ω	2 w				306-100
R622		82 k	1 w				304-823
R624		10 Ω	2 w				306-100
R625		10 Ω	2 w				306-100
R626		10 Ω	2 w				306-100
R628	101-1202 1203-up	10 Ω	1 w				304-100
		10 Ω	2 w				306-100
R633		270 k	1/2 w				302-274
R634		56 k	1/2 w				302-563
R637		1 k	1/2 w				302-102
R639		1.5 meg	1/2 w				302-155
R640		2 k	25 w		WW	5%	308-065
R641	101-149X	8 k	5 w		WW	5%	308-053
R642		1.5 meg	1/2 w				302-155
R643		2.2 meg	1/2 w				302-225
R644		180 k	1/2 w				302-184
R645		82 k	1/2 w				302-823
R647		2.2 meg	1/2 w				302-225
R648		333 k	1/2 w		Prec.	1%	309-053
R649		220 k	1/2 w		Prec.	1%	309-052
R653		47 k	1/2 w				302-473
R654		39 k	1/2 w				302-393
R656		680 k	1/2 w				302-684
R657		1.5 meg	1/2 w				302-155
R660		400 Ω	20 w		WW	5%	308-029
R663		333 k	1 w		Prec.	1%	310-056
R664		490 k	1 w		Prec.	1%	310-057
R666		4 k	5 w		WW	5%	308-051
R667		167 Ω	5 w		WW	5%	308-045
R668		167 Ω	5 w		WW	5%	308-045
R669	101-470 471-up	700 Ω	10 w		WW		Use 308-030
		750 Ω	20 w		WW	5%	308-030



## Resistors (continued)

							Part Number
							Tektronix
R672		22 k	1/2 w				302-223
R673		47 k	1/2 w				302-473
R677		1 meg	1/2 w				302-105
R678		1 k	1/2 w				302-102
R681		1 meg	1/2 w				302-105
R682		100 k	1/2 w				302-104
R684		1 k	1/2 w				302-102
R685		1.5 k	25 w		WW	5%	308-040
R687		33 k	1/2 w				302-333
R688		100 k	1/2 w				302-104
R689		1 k	1/2 w				302-102
R692		470 k	1/2 w				302-474
R693		100 k	1/2 w				302-104
R694		1 k	1/2 w				302-102
R695		100 k	1/2 w				302-104
R696		68 k	1/2 w				309-042
R697		10 k	2 w	Var.	Prec. WW	1% —150 Adj.	311-015
R698		50 k	1/2 w		Prec.	1%	309-090
R710		47 Ω	1/2 w				302-470
R712		47 Ω	1/2 w				302-470
R714		100 Ω	1/2 w				302-101
R716		47 Ω	1/2 w				302-470
R720		47 Ω	1/2 w				302-470
R722		47 Ω	1/2 w				302-470
R724		100 Ω	1/2 w				302-101
R726		47 Ω	1/2 w				302-470
R730		47 Ω	1/2 w				302-473
R734		100 k	1/2 w				302-104
R738		47 k	1/2 w				302-473
R742		100 k	1/2 w				302-104
R746		100 k	1/2 w				302-104
R800		1 k	1/2 w				302-102
R803		47 k	2 w				306-473
R804		3.3 k	1/2 w				302-332
R805		27 k	1/2 w				302-273
R807		390 Ω	1 w				304-391
R810		470 k	1/2 w				302-474
R811		2 meg	2 w	Var.		HV Adj.	311-042
R812		3.3 meg	1/2 w				302-335
R813		2.2 meg	1/2 w				302-225
R814		2.2 meg	1/2 w				302-225
R815		2.2 meg	1/2 w				302-225
R827	X1740-up	1.5 meg	1/2 w	Fixed		10%	302-155
R828	X1740-up	2.2 meg	1/2 w	Fixed		10%	302-225
R830		47 k	1/2 w				302-473
R831		1 meg	2 w	Var.		INTENSITY	311-041
R832		2.2 meg	1/2 w				302-225
R833		2.2 meg	1/2 w				302-225
R834		2.2 meg	1/2 w				302-225
R835		100 k	1/2 w				302-104
R836		1 meg	1/2 w				302-105
R843		100 Ω	1/2 w				302-101

### Resistors (continued)

						Tektronix Part Number	
R845		10 k	5 w		WW	5%	308-054
R846		100 $\Omega$	$\frac{1}{2}$ w				302-101
R848		100 k	$\frac{1}{2}$ w				302-104
R850		2.2 meg	1 w				304-225
R851		2.2 meg	1 w				304-225
R852		2 meg	2 w	Var.		FOCUS	311-043
R853		1 meg	$\frac{1}{2}$ w				302-105
R855		10 k	$\frac{1}{2}$ w				302-103
R856		27 k	$\frac{1}{2}$ w				302-273
R857		1 meg	$\frac{1}{2}$ w				302-105
R862		100 k	2 w	Var.		Geom. Adj.	311-026
R864		100 k	2 w	Var.		ASTIGMATISM	311-026

### Relays and Switches

				Wired	Unwired
SW558		Rotary	VOLTS, MILLIVOLTS, OFF SQUARE-WAVE CALIBRATOR }	*262-132	*260-177
SW576		Rotary			
K600			45-sec Thermal Time-delay relay		148-002
K601			6-v, 4-pole, double throw relay		148-004
K668			Current-Sensing relay		148-007
SW600		Toggle	SPST POWER ON		260-134
SW843		Rotary	INTENSITY MODULATION		*260-176

### Thermal Cutout

TK600	101-1202	Thermal Cutout 128°F.	260-070
	1203-up	Thermal Cutout 133°F.	260-208

### Transformers

T600	101-1202	Power 117 V operation	*120-090
		234 V operation	*120-092
	1203-up	Power 117/234 V operation	*120-143
T801		High Voltage	*120-091

### Electron Tubes

V204 †		12BY7A	*157-053
V224 †		12BY7A	*157-053
V233	101-1029	6BQ7A	154-028
	1030-up	6DJ8	154-187
V243	101-1029	6BQ7A	154-028
	1030-up	6DJ8	154-187

† V204 & V224 furnished as a unit.

Electron Tubes (continued)

			Tektronix Part Number
V254	101-614	5894	154-130
	615-up	6360	154-191
V264	X615-up	6360	154-191
V274	101-1029	6BQ7A	154-028
	1030-up	6DJ8	154-187
V304 †		12BY7A	*157-053
V324 †		12BY7A	*157-053
V333	101-1029	6BQ7A	154-028
	1030-up	6DJ8	154-187
V343	101-1029	6BQ7A	154-028
	1030-up	6DJ8	154-187
V354	101-614	5894	154-130
	615-up	6360	154-191
V364	X615-up	6360	154-191
V374	101-1029	6BQ7A	154-028
	1030-up	6DJ8	154-187
V555		6BQ7A	154-028
V565		6AU6	154-022
V606		6AU6	154-022
V607		6080	154-056
V617		6080	154-056
V634		6AU6	154-022
V637		6080	154-056
V646		12AX7	154-043
V656		6AU6	154-022
V674		6AU6	154-022
V687		6080	154-056
V689		5651	154-052
V696		12AX7	154-043
V800		6AQ5	154-017
V816		12AU7	154-041
V822		5642	154-051
V832		5642	154-051
V842		5642	154-051
V843	101-1029	6BQ7A	154-028
	1030-up	6DJ8	154-187
V859		T536 CRT P2 Standard Phosphor	*154-133

† V304 & V324 furnished as a unit.

# Type 536 Mechanical Parts List

	Tektronix Part Number
AIR FILTER	378-011
AIR FILTER HOUSING SN 101-1367	380-008
AIR FILTER HOUSING SN 1368-up	380-018
BAR, ALUM. $\frac{3}{16} \times \frac{1}{2} \times 1\frac{3}{4}$ w/2 8-32 tapped holes	381-073
BAR, TOP SUPPORT $20\frac{7}{16}$ SN 101-1367	381-122
BAR, TOP SUPPORT $20\frac{7}{16}$ SN 1368-up	381-150
BINDING POST ADAPTER	013-004
BINDING POST ground, metal	129-020
BINDING POST 5-way, black, fluted cap	129-036
BRACKET, POT $1 \times 1\frac{3}{16} \times \frac{1}{2}$	406-018
BRACKET, PHOSPHOR BRONZE, CRT SPRING	406-239
BRACKET, NYLON, COAX INSULATOR w/.640 hole	406-244
BRACKET, PHOSPHOR BRONZE, GROUND CLIP	406-245
BRACKET, CRT SUPPORT	406-251
BRACKET, DEFLECTION AMPLIFIER SWEEP	406-257
BRACKET, PHASE CAPACITOR SHAFT	406-261
BRACKET, CAPACITOR $6 \times 2\frac{1}{4} \times \frac{7}{8}$	406-263
BRACKET, PHASING CAPACITOR	406-395
BUSHING, PANEL, HEX $\frac{3}{8}$ -32 $\times 1\frac{13}{32} \times .252$ ID	358-029
BUSHING, NYLON, 5 W BINDING POST	358-036
BUSHING, BRASS .500 OD $\times .250$ hi.	358-049
CABINET BOTTOM SN 101-1367	386-597
CABINET BOTTOM SN 1368-up	387-061
CABINET SIDE SN 101-1367	386-737
CABINET SIDE SN 1368-up	387-069
CABLE HARNESS, DECOUPLING	179-149
CABLE HARNESS, F & I #1	179-150
CABLE HARNESS, POWER	179-152
CABLE HARNESS, 110 VOLT	179-155
CABLE HARNESS, F & I #2	179-236
CABLE HARNESS, HORIZONTAL SN 101-614	179-151
CABLE HARNESS, VERTICAL SN 101-614	179-154
CABLE HARNESS, TRANSFORMER SN 101-1202	179-153
CABLE HARNESS, HORIZ. AMP., RIGHT SN 615-up	179-269
CABLE HARNESS, VERT. AMP., LEFT SN 615-up	179-270
CABLE HARNESS, TRANSFORMERS, SILICON DIODE MOD. 1203-1799	179-366
CABLE HARNESS, TRANSFORMERS, SILICON DIODE MOD. 1800-up	179-557
CERAMIC STRIP $\frac{3}{4} \times 3$ notches, clip mounted	124-087

**Mechanical Parts List (continued)**

	Tektronix Part Number
CERAMIC STRIP $\frac{3}{4} \times 7$ notches, clip mounted	124-089
CERAMIC STRIP $\frac{3}{4} \times 9$ notches, clip mounted	124-090
CERAMIC STRIP $\frac{3}{4} \times 11$ notches, clip mounted	124-091
CERAMIC STRIP $\frac{3}{4} \times 1$ notches, clip mounted	124-100
CERAMIC POST, $\frac{1}{2}$ " SN 1971-up	129-009
CHAIN, STAINLESS STEEL, BEAD #6	214-006
CHASSIS, DEFLECTION AMP. RIGHT	441-132
CHASSIS, DEFLECTION AMP. LEFT	441-133
CHASSIS, HIGH VOLTAGE	441-148
CHASSIS, UPPER POWER	441-149
CHASSIS, LOWER POWER SN 101-1202	441-150
CHASSIS, LOWER POWER SN 1203-up	441-277
CLAMP, CABLE $\frac{3}{16}$ " plastic	343-002
CLAMP, CABLE $\frac{5}{16}$ "	343-004
CLAMP, CABLE $\frac{3}{8}$ " plastic	343-013
CONNECTOR, 16-CONTACT, FEMALE	131-018
CONNECTOR, BANANA JACK	131-031
CONNECTOR, CHASSIS MT., CAL. OUT	131-064
CONNECTOR, CABLE, solderless tube pin	131-074
CONNECTOR, CHASSIS MT., 3-WIRE, MALE SN 530-up	131-102
COUPLING, INSULATING, molded nylon ass'y	376-011
COUPLING, CAP ALUM. $\frac{3}{16}$ ID x $\frac{3}{8}$ OD x $\frac{1}{2}$	376-016
COUPLING, BEAD CHAIN #6A	376-017
CRT CABLE PIN CONNECTOR	131-049
CRT ANODE CABLE CONNECTOR 31"	131-086
CRT CONTACT PLUG	134-031
CRT ANODE AND PLATE ASS'Y COVER	200-112
CRT ROTATOR SECURING RING	354-078
CRT ROTATOR CLAMPING RING	354-079
CRT ROTATOR BASE	432-022
EYELET, TAPERED BARREL	210-601
FAN MOTOR	147-001
FAN RING $7\frac{3}{8}$ "	354-053
FAN BLADE 7"	369-007
FAN MOTOR MOUNT	426-047
FELT STRIP $\frac{1}{8} \times 1 \times 5\frac{3}{4}$	124-068

Mechanical Parts List (continued)

Tektronix  
Part Number

FRAME ANGLE, TOP LEFT	122-030
FRAME ANGLE, BOTTOM SN 101-1367	122-029
FRAME ANGLE, BOTTOM SN 1368-up	122-079
FUSE CAP	200-015
FUSE HOLDER	352-010
GRATICULE LAMP SOCKET	136-001
GRATICULE COVER	200-025
GRATICULE, 10 div Vert. x 10 div Horiz.	331-028
GRATICULE, 5" phase angle measurement	331-057
GRATICULE LIGHT FILTER, GREEN	378-514
GROMMET, RUBBER 1/4"	348-002
GROMMET, RUBBER 5/16"	348-003
GROMMET, RUBBER 3/8"	348-004
GROMMET, RUBBER 1/2"	348-005
GROMMET, RUBBER 3/4"	348-006
HOLDER, NEON BULB, double	352-006
JEWEL LIGHT SOCKET	136-025
JEWEL, RED, PILOT LIGHT	378-518
KNOB, SMALL RED 3/16 insert hole	366-032
KNOB, SMALL BLACK 1/4 insert hole	366-033
KNOB, SMALL RED 1/8 hole part way	366-038
KNOB, LARGE BLACK 1/4 hole thru	366-040
KNOB, LARGE BLACK 1/4 hole part way	366-042
LOCKWASHER #4 INT	210-004
LOCKWASHER #6 INT	210-006
LOCKWASHER #8 EXT	210-007
LOCKWASHER #8 INT	210-008
LOCKWASHER #10 INT	210-010
LOCKWASHER 1/4 INT	210-011
LOCKWASHER Pot INT	210-012
LOCKWASHER 3/8 x 11/16 INT	210-013
LUG, SOLDER SE4	210-201
LUG, SOLDER SE6 w/2 wire holes	210-202
LUG, SOLDER SE10 long	210-206
LUG, SOLDER 1/4" hole, locking	210-223
LUG, SOLDER #10 non-locking	210-224

Mechanical Parts List (continued)

	Tektronix Part Number
LUG, SOLDER SE8 long	210-228
NUT, HEX 8-32 x 5/16	210-402
NUT, HEX 4-40 x 3/16	210-406
NUT, HEX 6-32 x 1/4	210-407
NUT, HEX 8-32 x 5/16	210-409
NUT, HEX 10-32 x 5/16	210-410
NUT, HEX 3/8-32 x 1/2	210-413
NUT, HEX 15/32-32 x 9/16	210-414
NUT, GRATICULE	210-424
NUT, POT 1/2 x 5/8 3/8-32 int. thread	210-444
NUT, HEX 10-32 x 1/8 x 1/8	210-445
NUT, CABINET FASTENER 8-32	210-480
NUT, HEX 1/4 x 3/8 x 3/32	210-455
NUT, KEPS 6-32 x 5/16	210-457
NUT, KEPS 8-32 x 11/32	210-458
NUT, HEX 8-32 x 1/2 x 23/64 25 W resistor mtg.	210-462
NUT, SWITCH 12-sided	210-473
NUT, HEX 6-32 x 5/16 x .194 5-10 W resistor mtg.	210-478
NUT, SQUARE 10-32 x 3/8	210-501
NUT, CRT ROTATOR 10-32 x 3/8	210-502
NUT, 21/32 x 2 1/2, tapped 6-32 both ends	210-503
OVERLAY, REAR SN 101-1367	386-979
OVERLAY, REAR SN 1368-up	387-080
PANEL, FRONT	333-215
PATCH CORD, RED BANANA	012-031
POWER CORD ADAPTER	103-013
POWER CORD, 8 foot, 3-wire	161-010
PLATE .040 x 9/16 x 1 17/32, connecting	386-374
PLATE, PLEXIGLASS .125 x 1 x 1	386-589
PLATE, ALUM. PLUG-IN HOUSING TOP SHIELD	386-752
PLATE, TUBE SUPPORT .025 x 3/8 x 1 5/8	386-839
PLATE, TUBE MOUNTING	386-840
PLATE, SILICON DIODE SUPPORT 6 7/8 x 12 1/2, SN 1203-up	386-973
PLATE, PLEXIGLASS, TRIMMER MTG.	386-858
PLUG, BANANA, FEMALE 6-32 tap	134-013
PLUG-IN HOUSING, BACK	386-607
PLUG-IN HOUSING, TOP	386-609



**Mechanical Parts List (continued)**

	Tektronix Part Number
PLUG-IN HOUSING, BOTTOM	386-610
PLUG-IN HOUSING, CENTER, LEFT & RIGHT	386-611
PLUG-IN HOUSING, OUTSIDE, LEFT & RIGHT	386-614
PLUG-IN HOUSING, TOP SHIELD	386-752
PULLEY, BRASS .250 shaft hole w/2 6-32 holes	401-006
PULLEY, 1½" diameter	401-008
ROD, EXTENSION, ALUM. ¼ x 11½/16	384-091
ROD, EXTENSION, ALUM. ¼ x 5¾/8	384-150
ROD, NYLON 5/16 x 1, tapped, 6-32 thru	385-016
ROD, NYLON 5/16 x 1¼, tapped, 6-32 both ends	385-018
ROD, NYLON 5/16 x 2, tapped, 6-32 one end w/pin	385-047
ROD, NYLON 5/16 x 1, tapped, 6-32 w/#44 hole SN 101-1709	385-074
ROD, NYLON 5/16 x 1½/16 Mtg. hole ¾ deep w/2 #44 holes SN 1710-up	385-135
ROD, NYLON 5/16 x 1⅛, tapped, 6-32 w/2 #44 holes SN 101-1709	385-075
ROD, NYLON 5/16 x 1½/16 Mtg. hole ¾ deep w/2 #44 holes SN 1710-up	385-135
ROD, ALUM., HEX ¼ x 7/16	385-080
ROD, NYLON 5/16 x 1¾/16 Mtg. hole ¾ deep w/4 #44 holes SN 1710-up	385-138
ROD, NYLON 5/16 x 1⅝, tapped, 6-32 w/2 #44 holes SN 101-1709	385-085
ROD, ALUM., ¼ x 5½/16, tapped 6-32 both ends	385-095
ROD, NYLON ¼ x 2½/2, tapped 4-40 both ends	385-117
ROD, NYLON ¾ x 1, tapped 6-32 one end	385-118
RING, LOCKING SWITCH 2¾/32 OD x 1½/32 ID	354-055
RING, ORNAMENTAL, REAR 21½/16 x 14½/32	354-103
SCREW 4-40 x ¼ BHS	211-008
SCREW 4-40 x 5/16 BHS	211-011
SCREW 4-40 x 5/8 RHS	211-016
SCREW 4-40 x ¾ FHS	211-025
SCREW 4-40 x 1 FHS	211-031
SCREW 4-40 x 5/16 Pan HS w/lockwasher	211-033
SCREW 6-32 x ¾/16 BHS	211-503
SCREW 6-32 x ¼ BHS	211-504
SCREW 6-32 x 5/16 BHS	211-507
SCREW 6-32 x 5/16 FHS	211-508
SCREW 6-32 x ¾ FHS	211-509
SCREW 6-32 x ¾ BHS	211-510
SCREW 6-32 x ½ BHS	211-511
SCREW 6-32 x ½ FHS	211-512
SCREW 6-32 x 5/8 BHS	211-513
SCREW 6-32 x ¾ FHS	211-515

**Mechanical Parts List** (continued)

	Tektronix Part Number
SCREW 6-32 x 5/8 FHS	211-522
SCREW 6-32 x 5/16 Pan HS w/lockwasher	211-534
SCREW 6-32 x 3/8 Truss HS Phillips	211-537
SCREW 6-32 x 5/16 FHS 100° Phillips	211-538
SCREW 6-32 x 5/16 RHS	211-543
SCREW 6-32 x 3/4 Truss HS Phillips	211-544
SCREW 6-32 x 1 1/2 RHS Phillips	211-553
SCREW 6-32 x 1 RHS	211-560
SCREW 6-32 x 3/8 HEX SOC. FH CAP	211-561
SCREW 8-32 x 5/16 BHS	212-004
SCREW 8-32 x 2 1/2 RHS	212-015
SCREW 8-32 x 3/8 BHS	212-023
SCREW 8-32 x 1 1/4 RHS	212-031
SCREW 8-32 x 1 3/4 Fil HS	212-037
SCREW 8-32 x 3/8 Truss HS Phillips	212-039
SCREW 8-32 x 3/8 FHS 100° Phillips	212-040
SCREW 10-32 x 3/8 BHS	212-507
SCREW 10-32 x 3 RHS	212-511
SCREW 10-32 x 6 1/4 RHS	212-532
SCREW 10-32 x 7/8 RHS	212-548
SCREW, SET 8-32 x 1/8 HSS	213-005
SCREW, SET 6-32 x 1/8 HHS	213-020
SCREW, FASTENING STEEL 1/2 x 1/2 x 1/4	213-033
SCREW, THREAD CUTTING 4-40 x 1/4 PHS Phillips	213-035
SCREW, THREAD CUTTING 6-32 x 3/8 Truss HS Phillips	213-041
SCREW, THREAD CUTTING 5-32 x 3/16 Pan H Steel	213-044
SHIELD, ALUM. 4 31/32 x 9 3/4 HV	337-161
SHIELD, 5" CRT	337-175
SHIELD, 1 15/32 x 1 21/32 x 3/4 Cal	337-176
SHIELD, 5" GRATICULE LIGHT	337-187
SHOCKMOUNT, RUBBER 1/2" dia. x 5/8 hi.	348-008
SOCKET, STM7	136-008
SOCKET, STM8, ground	136-011
SOCKET, STM9G	136-015
SOCKET, STM14 1 1/8" thick	136-019
SOCKET, TIP JACK	136-037

**Mechanical Parts List (continued)**

	Tektronix Part Number
SPACER, .180 ID x 1/4 OD x 1/4	166-031
SPACER, ALUM. .245 ID x 3/8 OD x 2 <sup>19</sup> / <sub>32</sub>	166-105
SPACER, ALUM. .180 ID x 1/4 OD x 7/32	166-107
SPACER, NYLON 5/32 for ceramic strip	361-007
SPACER, NYLON 3/8 for ceramic strip	361-009
SPRING, PULLEY .016 spring steel wire x 1 1/2	214-007
STOP, ROTATION	105-001
STOP, STEEL 7/32 x 2 <sup>1</sup> / <sub>32</sub> OD	105-007
STRAP, MTG., HV TRANSFORMER	346-001
STUD, STEEL 10-32 x 2 <sup>7</sup> / <sub>16</sub>	355-044
STUD, STEEL 10-32 x 3 <sup>1</sup> / <sub>4</sub> x 3/16	355-049
SUBPANEL, FRONT	386-591
SUBPANEL, REAR	386-766
TUBING #2 BLACK PLASTIC	162-004
TUBING #18 BLACK PLASTIC	162-007
TUBING #7 CLEAR PLASTIC	162-012
TUBING #4 CLEAR PLASTIC	162-018
TUBING #20 BLACK PLASTIC	162-504
WASHER 5S x 5/32 x .025	210-801
WASHER 6S x 5/16 x .028	210-802
WASHER 6L x 3/8 x .032	210-803
WASHER 8S x 3/8 x .032	210-804
WASHER 10S x 7/16 x .036	210-805
WASHER, 20w resistor centering	210-808
WASHER, 25w resistor centering	210-809
WASHER, FIBER #10	210-812
WASHER, RUBBER WAN 12-20	210-816
WASHER .390 ID x 5/16 OD .020	210-840
WASHER, NYLON	210-847
WASHER .119 ID x 3/8 OD x .025	210-851
WASHER, RUBBER, for fuse holder	210-873
WASHER .470 ID x 2 <sup>1</sup> / <sub>32</sub> OD x .030	210-902
WASHER, WAVY BRONZE	210-914
WIRE #18 SOLID, YELLOW	175-503
WIRE #22 SOLID, WHITE	175-522
WIRE #22 STRANDED, WHITE	175-527
WIRE #26 STRANDED, WHITE	175-529
WIRE #22 SOLID, POLY	175-549
WIRE #24 BRAIDED	176-045



## EXPORT POWER TRANSFORMER

### Transformer Primary

The instrument for which this manual was prepared is equipped with a special transformer. The transformer has eight primary terminals making possible six different input connections. The six primary connections are shown in Fig. 1.

**POWER TRANSFORMER HAS TWO EXTRA WINDINGS PERMITTING  
NOMINAL PRIMARY VOLTAGES OF 110, 117, 124, 220, 234, OR 248 V,  
50 OR 60~ OPERATION.**

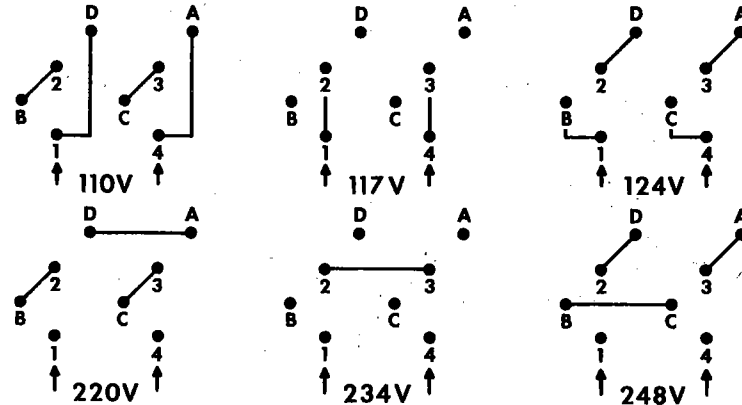

Fig.1. The power transformer has two extra windings permitting nominal primary voltages of 110, 117, 124, 220, 234, 248 volts, 50 or 60 cycle operation.

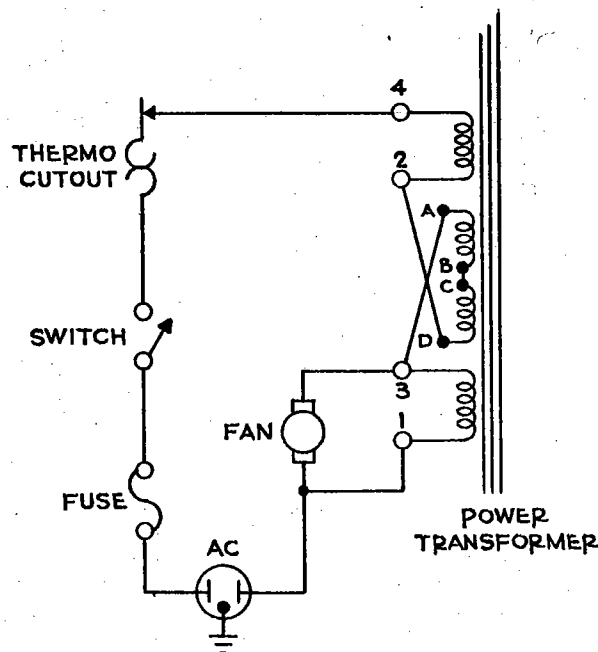
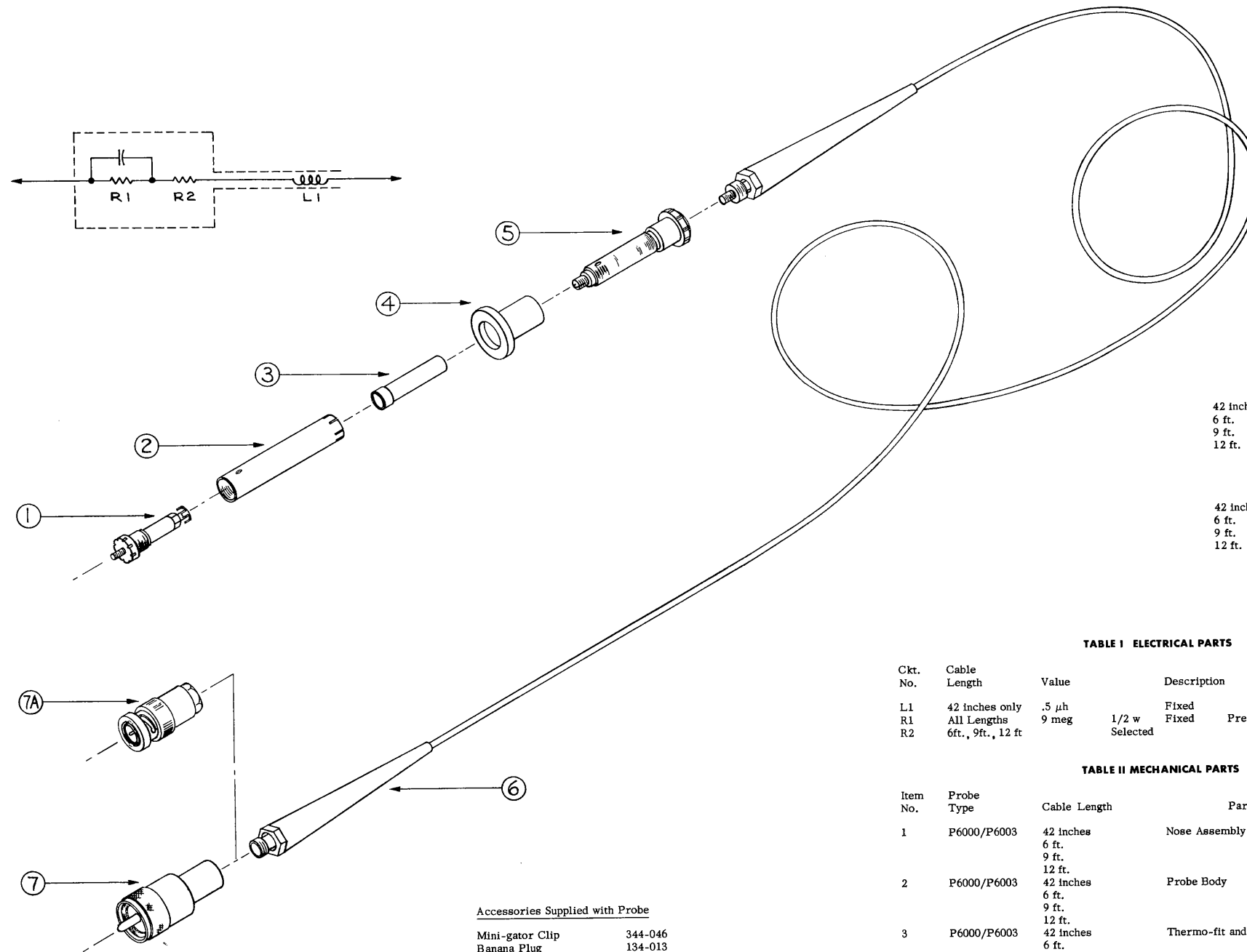

Fig. 2. When connecting the power transformer for operation with a supply voltage of 200 volts or more, be sure that the fan is connected between pins 1 and 3 of the primary. This is to insure that the fan is supplied with no more than 125 volts. Fig. 2 shows a typical high-voltage fan connection, using as an example the wiring for a 248 volt supply.



**PROBES THIS SHEET COVERS**

P6000			
42 inches	Tektronix Part No.	010-020	
6 ft.		010-030	
9 ft.		010-035	
12 ft.		010-041	
P6003			
42 inches	Tektronix Part No.	010-027	
6 ft.		010-031	
9 ft.		010-045	
12 ft.		010-046	

**TABLE I ELECTRICAL PARTS**

Ckt. No.	Cable Length	Value	Description	Tektronix Part No.
L1	42 inches only	.5 $\mu$ h	Fixed	108-211
R1	All Lengths	9 meg	1/2 w Fixed Prec. 2%	309-232
R2	6ft., 9ft., 12 ft		Selected	

**TABLE II MECHANICAL PARTS**

Item No.	Probe Type	Cable Length	Part Title	Tektronix Part No.
1	P6000/P6003	42 inches	Nose Assembly	206-014
		6 ft.		206-014
		9 ft.		206-068
		12 ft.		206-056
2	P6000/P6003	42 inches	Probe Body	204-021
		6 ft.		204-021
		9 ft.		204-021
		12 ft.		204-057
3	P6000/P6003	42 inches	Thermo-fit and Sleeve Assembly	166-212
		6 ft.		166-214
		9 ft.		166-219
		12 ft.		166-216
4	P6000	42 inches	Locking Ring	105-022
		42 inches		105-028
		6 ft.		105-024
		6 ft.		105-025
		9 ft.		105-029
		9 ft.		105-033
		12 ft.		105-030
5	P6000/P6003	All Lengths	Assembly Base Bushing	358-121
		42 inches		175-159
6	P6000	42 inches	Cable Assembly	175-162
		42 inches		175-162
		6 ft.		175-165
		6 ft.		175-168
		9 ft.		175-171
		9 ft.		175-174
		12 ft.		175-177
		12 ft.		175-180
		All Lengths		131-058
		All Lengths		131-185

**Accessories Supplied with Probe**

Mini-gator Clip	344-046
Banana Plug	134-013
Probe Holder	352-024
Hook Tip	206-023
BNC Tip	206-015
Spring Tip	206-060
Pincer Tip	013-027
5 inch Ground Strap	175-124
12 inch Ground Strap	175-125

**Accessories That May be Purchased**

BNC to Probe Adaptor	013-020
Spring Tip without Shank	206-061
Pinjack Tip, Insulated	206-054
Insert Tip	206-052
Pinjack Tip	206-045
Straight Tip	206-034
18 inch Ground Strap	175-184

MRII

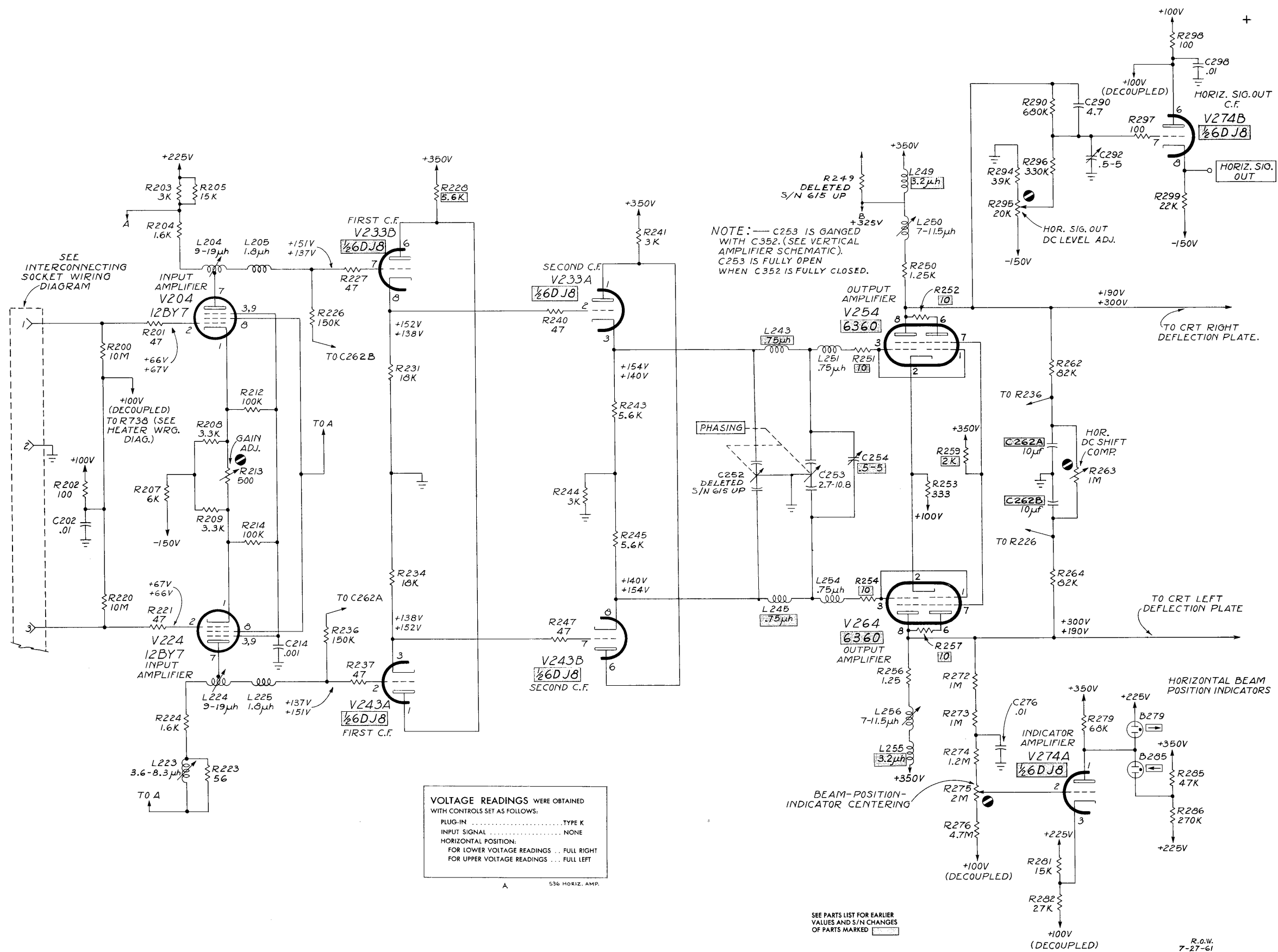

VOLTAGE READINGS WERE OBTAINED WITH CONTROLS SET AS FOLLOWS:

PLUG-IN	.....	TYPE K
INPUT SIGNAL	.....	NONE
HORIZONTAL POSITION:	.....	
FOR LOWER VOLTAGE READINGS	.....	FULL RIGHT
FOR UPPER VOLTAGE READINGS	.....	FULL LEFT

A 536 HORIZ. AMP.

SEE PARTS LIST FOR EARLIER VALUES AND S/N CHANGES OF PARTS MARKED

R.O.W. 7-27-61



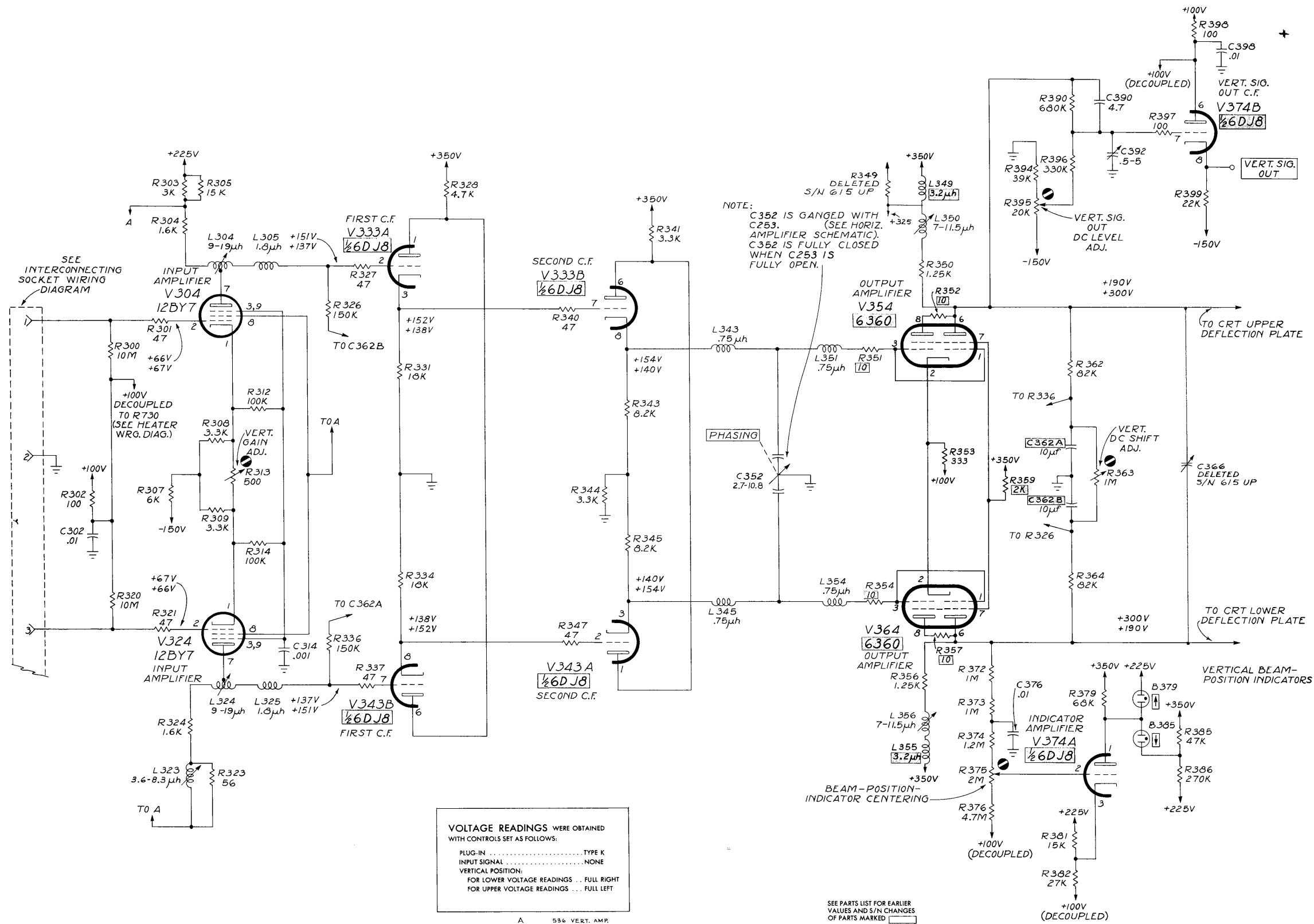

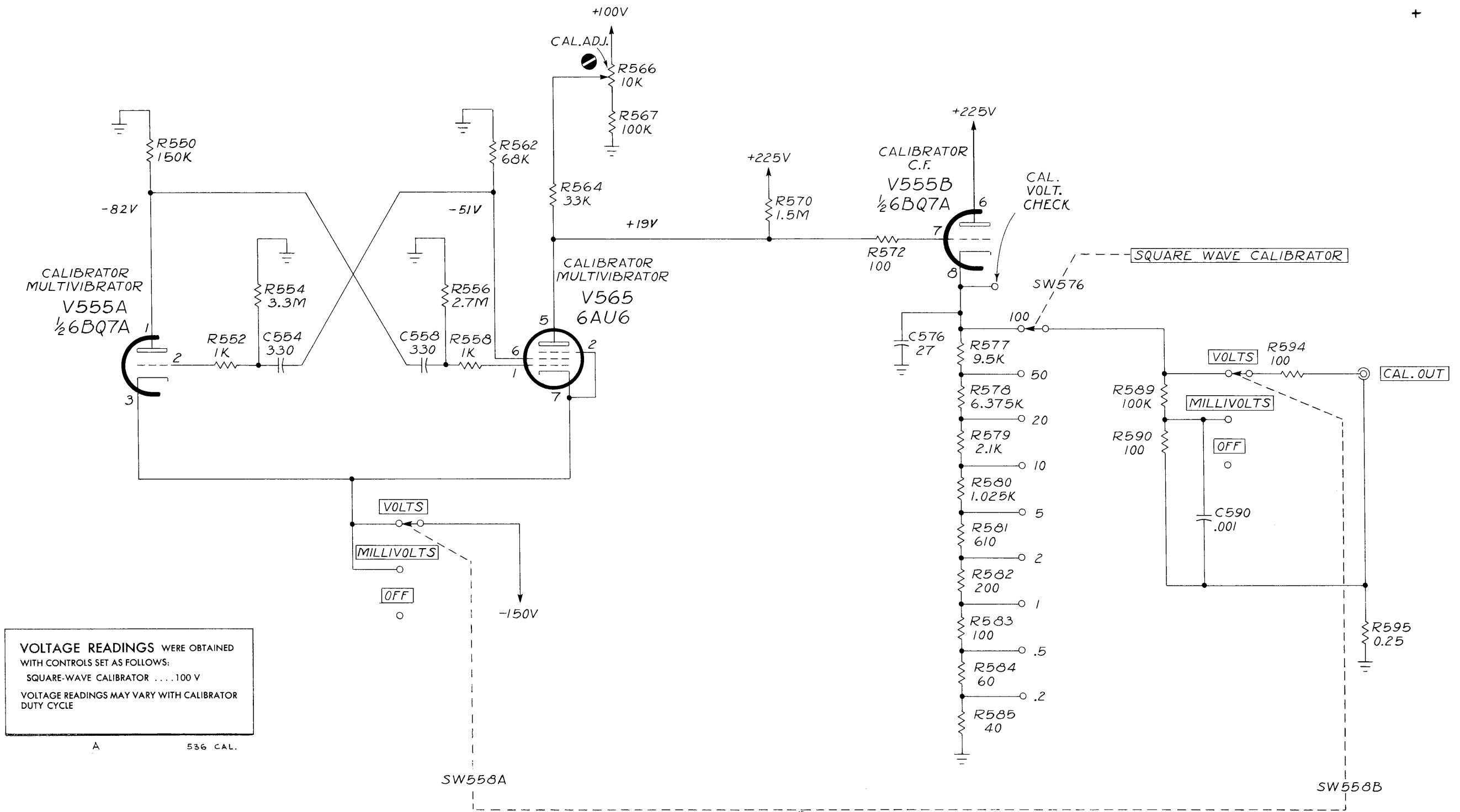

VOLTAGE READINGS WERE OBTAINED WITH CONTROLS SET AS FOLLOWS:  
 SQUARE-WAVE CALIBRATOR . . . . 100 V  
 VOLTAGE READINGS MAY VARY WITH CALIBRATOR DUTY CYCLE

A 536 CAL.

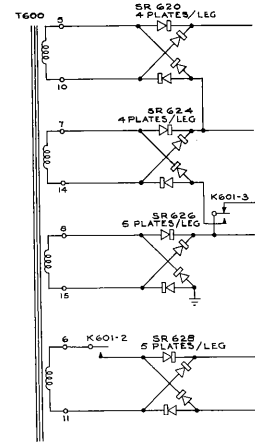
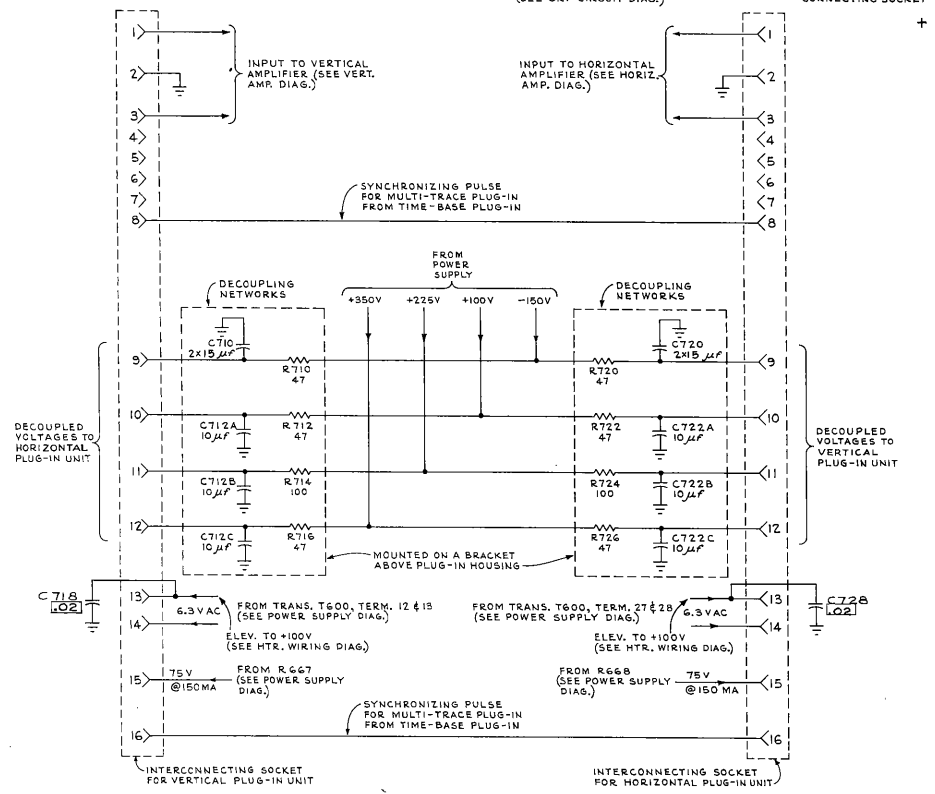
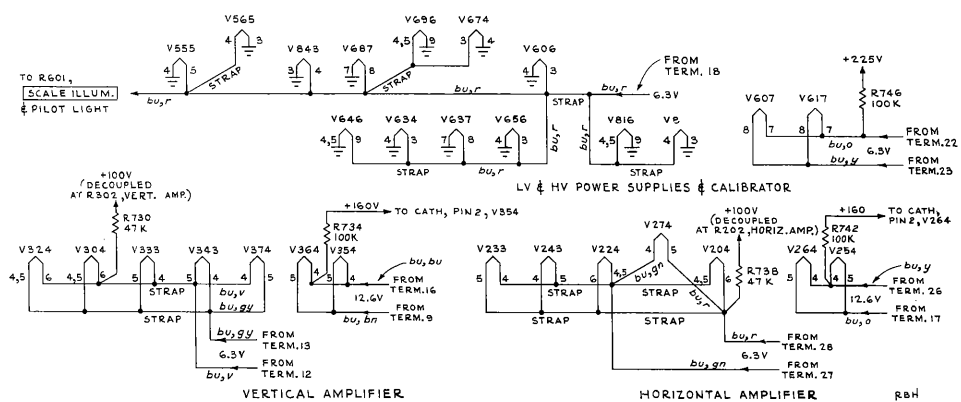

PLATE SUPPLIES  
S/N 101-1203



INTERCONNECTING SOCKET WIRING DIAGRAM



HEATER WIRING DIAGRAM

TYPE 536 OSCILLOSCOPE

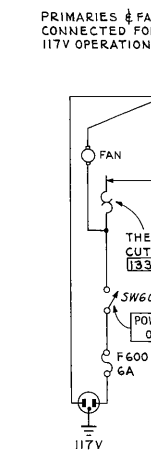
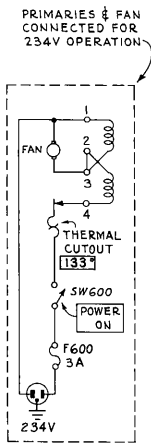

5-31-61

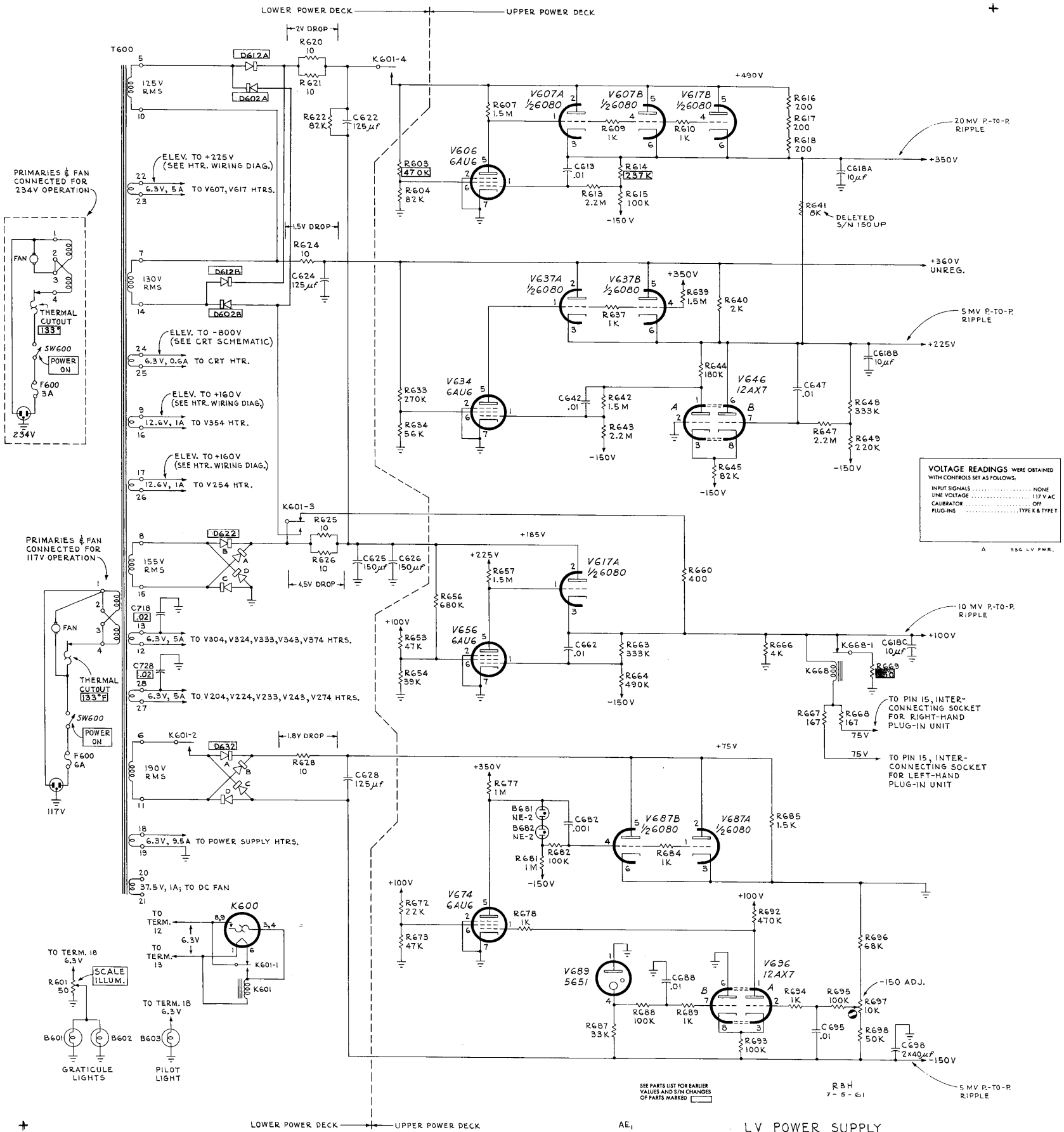

VOLTAGE READINGS WERE OBTAINED WITH CONTROLS SET AS FOLLOWS:  
 INPUT SIGNALS ..... NONE  
 LINE VOLTAGE ..... 117 V AC  
 CALIBRATOR ..... OFF  
 PLUG-INS ..... TYPE K & TYPE T

AE1 LV POWER SUPPLY

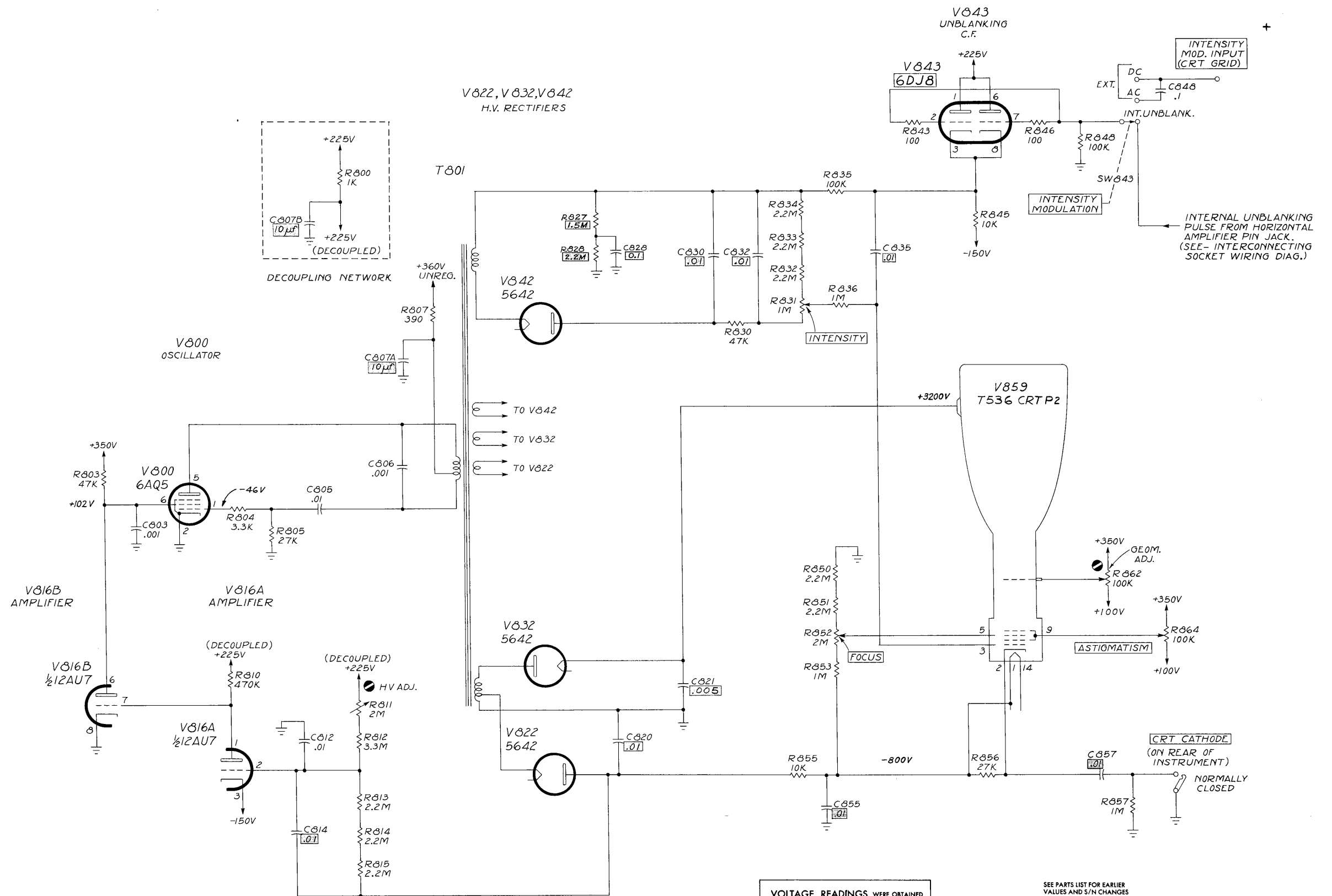

VOLTAGE READINGS WERE OBTAINED WITH CONTROLS SET AS FOLLOWS:  
 INTENSITY ..... FULL LEFT

SEE PARTS LIST FOR EARLIER VALUES AND S/N CHANGES OF PARTS MARKED

A 536 CRT CIRCUIT

R.O.W.  
 5-2-61

# **K4XL's** **BAMA**

This manual is provided **FREE OF CHARGE** from the “BoatAnchor Manual Archive” as a service to the Boatanchor community.

It was uploaded by someone who wanted to help you repair and maintain your equipment.

If you paid anyone other than BAMA for this manual, you paid someone who is making a profit from the free labor of others without asking their permission.

You may pass on copies of this manual to anyone who needs it. But do it without charge.

Thousands of files are available without charge from BAMA. Visit us at <http://bama.sbc.edu>